

# Koeltechnische toebehoren

## Filterdrogers • F-2

*Danfoss*



**Castel**

## Terugslagkleppen • F-13

*Danfoss*

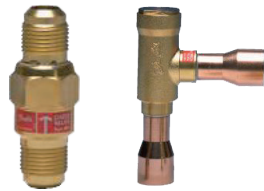

**Castel**

## Kranen en afsluiters • F-18

*Danfoss*



**Castel**

## Rotalock • F-28

**Castel**



## Oliefascheiders • F-33

**ESK Schultze**  
Kältekomponenten



**Castel**

## Olieniveauregelaars • F-36

**ESK Schultze**  
Kältekomponenten



**EMERSON**  
Climate Technologies

## Mufflers • F-45

**ESK Schultze**  
Kältekomponenten



## Magneetventielen • F-10

*Danfoss*



**Castel**

## Kijkglazen • F-15

*Danfoss*



**Castel**

## Overdruk beveiliging • F-27

**Castel**



## Vloeistofvaten • F-32

**denaline**  
refrigeration and air conditioning equipment

**FRIGO MEC**



## Oliereservoirs • F-34

**ESK Schultze**  
Kältekomponenten



**denaline**  
refrigeration and air conditioning equipment

## Vloeistof afscheiders • F-42

**ESK Schultze**  
Kältekomponenten



**FRIGO MEC**

## Overige • F-46

**HENRY**  
TECHNOLOGIES  
GERMANY

**kmp**



F

F-1



Pg. F-5



Pg. F-10



Pg. F-15

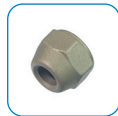

Pg. G-22



Pg. G-24



## FILTERDROGERS

### VASTE KERN



- Verkrijgbaar in flare en soldeeruitvoering.
- Voor HFC koelmiddelen, alsook voor minerale en ester oliën
- 100% moleculaire zeven

#### Flare

Art. Nr.	Type	Alternatief	Verbinding - Flare	Vol.	Max. werkdruk	Lengte	Diameter	Prijs
			Inch					
00000035	4303/2	DF303/2	1/4"	50	50	110	42	15,77
00000036	4305/2	DF305/2	1/4"	80	50	123	64	21,17
00000037	4305/3	DF305/3	3/8"	80	50	134	64	22,33
00000038	4308/2	DF308/2	1/4"	130	50	143	64	25,00
00000039	4308/3	DF308/3	3/8"	130	50	153	64	25,00
00000040	4308/4	DF308/4	1/2"	130	50	157	64	35,15
00000041	4316/2	DF316/2	1/4"	250	50	168	64	33,49
00000042	4316/3	DF316/3	3/8"	250	50	178	64	32,82
00000043	4316/4	DF316/4	1/2"	250	50	182	64	34,01
00000044	4316/5	DF316/5	5/8"	250	50	192	64	40,33
00000045	DF330/4	4332/4	1/2"	500	50	246	76	53,05
00000046	4332/5	DF330/5	5/8"	500	50	256	76	53,05
00000047	4341/5	DF341/5	5/8"	670	50	265	89	75,80
00000048	4341/6	DF341/6	3/4"	670	50	274	89	77,85

## F

### F-2

#### Soldeer

Art. Nr.	Type	Alternatief	Verbinding - Soldeer	Vol.	Max. werkdruk	Lengte	Diameter	Prijs
			Inch					
00000020	4303/2S	DF303/2S	1/4"	50	50	101	42	19,70
00000021	4305/2S	DF305/2S	1/4"	80	50	115	64	17,45
00000022	4305/3S	DF305/3S	3/8"	80	50	117	64	22,33
00000023	4308/2S	DF308/2S	1/4"	130	50	134	64	25,00
00000024	4308/3S	DF308/3S	3/8"	130	50	136	64	25,00
00000025	4308/4S	DF308/4S	1/2"	130	50	138	64	31,64
00000027	4316/3S	DF316/3S	3/8"	250	50	157	64	33,49
00000028	4316/4S	DF316/4S	1/2"	250	50	158	64	34,01
00000029	4316/5S	DF316/5S	5/8"	250	50	163	64	39,90
00000030	4332/4S	DF330/4S	1/2"	500	50	229	76	71,42
00000031	4332/5S	DF330/5S	5/8"	500	50	235	76	67,03
00000032	4341/5S	DF341/5S	5/8"	670	50	236	89	75,80
00000033	4341/6S	DF341/6S	3/4"	670	50	246	89	77,85

## FILTERDROGERS

### VASTE KERN - DML



Flare



Soldeer

- Testdruk 42 Bar.
- Verkrijgbaar in flare en soldeeruitvoering.
- Voor HFC koelmiddelen, alsook voor minerale en ester oliën.
- 100% moleculaire zeven.
- Temperatuur bereik: -40°C ~ + 70°C.



Pg. F-5



Pg. F-10



Pg. F-15



Pg. G-22



Pg. G-24

#### Flare

Art. Nr	Type	Code Danfoss	Verbinding - Flare		Vol.	Max. werkdruk	Lengte	Prijs
			Inch	cm <sup>3</sup>				
00000103	DML032	023Z5035	1/4	41	42	110	18,60	
00000105	DML052	023Z5037	1/4	67	42	119	22,30	
00000106	DML053	023Z5038	3/8	67	42	132	22,30	
00000107	DML082	023Z5039	1/4	104	42	145	27,90	
00000108	DML083	023Z5040	3/8	104	42	158	27,90	
00000109	DML084	023Z5041	1/2	104	42	166	27,90	
00000110	DML162	023Z5042	1/4	234	42	154	37,10	
00000111	DML163	023Z5043	3/8	234	42	167	37,10	
00000112	DML164	023Z5044	1/2	234	42	175	37,10	
00000113	DML165	023Z5045	5/8	234	42	184	37,10	
00000114	DML303	023Z0049	3/8	494	42	243	52,00	
00000115	DML304	023Z0050	1/2	494	42	251	52,00	
00000116	DML305	023Z0051	5/8	494	42	260	52,00	
00010131	DML306	023Z0193	3/4	494	42	258	52,00	

#### Soldeer: koper bimetaal soldeeraansluiting

Art. Nr	Type	Code Danfoss	Verbinding - Soldeer		Vol.	Max. werkdruk	Lengte	Prijs
			Inch	cm <sup>3</sup>				
00000117	DML032S	023Z4552	1/4	41	46	98	19,50	
00000119	DML033S	023Z4555	3/8	41	46	104	19,50	
00000120	DML052S	023Z4559	1/4	67	46	107	23,40	
00000121	DML053S	023Z4562	3/8	67	46	113	23,40	
00000122	DML082S	023Z4567	1/4	104	46	133	29,30	
00000123	DML083S	023Z4570	3/8	104	46	139	29,30	
00000124	DML084S	023Z4572	1/2	104	46	143	29,30	
00000126	DML163S	023Z4578	3/8	234	46	148	39,00	
00000127	DML164S	023Z4580	1/2	234	46	152	39,00	
00000128	DML165S	023Z4581	5/8	234	46	160	39,00	
00000131	DML305S	023Z4588	5/8	494	46	236	54,60	
00000132	DML307S	023Z4590	7/8	494	46	246	54,60	
00055801	DML604S	023Z4600	1/2	988	46	379	77,90	
00055802	DML607S	023Z4602	7/8	988	46	397	77,90	
00055803	DML759S	023Z4607	1.1/8	1363	46	402	89,60	

F

F-3



Pg. F-5



Pg. F-10



Pg. F-15



Pg. G-22



Pg. G-24



## FILTERDROGERS

### VASTE KERN MET VOCHTIGHEIDSINDICATOR



- Verkrijgbaar in flare en soldeeruitvoering
- Europese makelij
- Voor HFC koelmiddelen, alsook voor minerale en ester oliën
- 100% moleculaire zeven

#### Flare

Art. Nr	Type	Verbinding - Flare		Vol.	Max. werkdruk	
		Inch	cm <sup>3</sup>		Bar	EUR
00060683	4108/2	1/4	130	45	49,92	
00060682	4108/3	3/8	130	45	52,42	
00065553	4108/4	1/2	130	45	54,95	
00065554	4116/3	3/8	250	45	59,15	
00105374	DI316N/4	1/2	250	45	60,86	
00105375	DI316N/5	5/8	250	45	64,23	

#### Soldeer

Art. Nr	Type	Verbinding - Soldeer		Vol.	Max. werkdruk	
		Inch	cm <sup>3</sup>		Bar	EUR
00065560	4108/2S	1/4	130	45	49,92	
00065561	4108/3S	3/8	130	45	52,42	
00065562	4108/4S	1/2	130	45	54,95	
00065563	4116/3S	3/8	250	45	59,15	
00065564	4116/4S	1/2	250	45	60,86	
00065565	4116/5S	5/8	250	45	64,23	

F

F-4

## UNIVERSELE SHELLDROGERS MET VERWISSELBARE KERNEN



Pg. F-18



4411/.. A

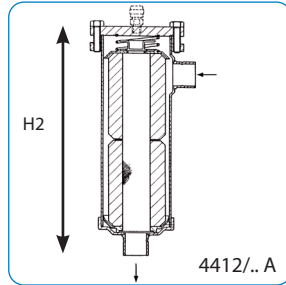

4412/.. A

- Geleverd zonder kernen.
- Aluminium flensen, geen corrosie.
- Met koper soldeeraansluiting, ook verkrijgbaar met staalaansluiting.
- Inclusief schraederkoppeling 1/4" NPT x 1/4" SAE en afdichtingstop 1/4" NPT (voor deksel).

**Voor vloeistofleiding: 4490/A of 4491/A-kern gebruiken**  
**Voor burn-out in de zuigleiding 4490/AA of 4491/AA gebruiken**

Art. Nr	Type	Verbinding - Soldeer		Aantal kernen	Voor kern	Vol. cm <sup>3</sup>	Max. werkdruk Bar	Lengte H2 mm	Prijs EUR
		Inch							
00107377	4411/5AF	5/8		1	4490/A - AA	800	50	231	0
00101778	4411/9A	1.1/8		1	4490/AF - AA	800	45	237	227
00000054	4411/11A	1.3/8		1	4490/A - AA	800	45	242	232
00000055	4411/13A	1.5/8		1	4490/A - AA	800	45	254	240
00000056	4411/17A	2.1/8		1	4490/A - AA	800	45	245	250
00065574	4411/21A	2.5/8		1	4490/A - AA	800	45	269	289
00107380	4412/7A	7/8		2	4490/A - AA	1600	50	379	0
00000058	4412/9A	1.1/8		2	4490/A - AA	1600	45	379	264
00000059	4412/11A	1.3/8		2	4490/A - AA	1600	45	384	269
00056500	4412/17A	2.1/8		2	4490/A - AA	1600	45	387	287
00000060	4413/11A	1.3/8		3	4490/A - AA	2400	45	525	320
00000061	4413/13A	1.5/8		3	4490/A - AA	2400	45	537	328
00000062	4414/13A	1.5/8		4	4490/A - AA	3200	35	679	379
00000063	4414/17A	2.1/8		4	4490/A - AA	3200	35	670	389
00022856	4423/17A	2.1/8		3	4491/A - AA	4800	32	641	1 014
00028505	4423/21A	2.5/8		3	4491/A - AA	4800	32	641	1 073



4411/.. C

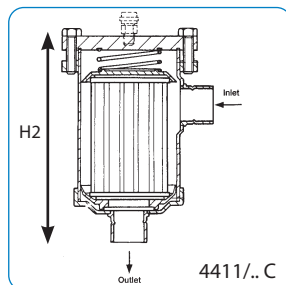

4411/.. C

- Geleverd zonder kernen.
- Aluminium flensen, geen corrosie.
- Met koper soldeeraansluiting, ook verkrijgbaar met staalaansluiting.
- Inclusief schraederkoppeling 1/4" NPT x 1/4" SAE en afdichtingstop 1/4" NPT (voor deksel).

**Voor zuigleiding**

Art. Nr	Type	Verbinding - Soldeer		Aantal kernen	Voor kern	Max. werkdruk Bar	Lengte H2 mm	Prijs EUR
		Inch						
00014179	4411/7C	7/8		1	4495/C	45	237	236,49
00014180	4411/9C	1.1/8		1	4495/C	45	237	199,34
00014181	4411/11C	1.3/8		1	4495/C	45	242	202,91
00014182	4411/13C	1.5/8		1	4495/C	45	254	256,20
00107423	4411/17CF	2.1/8		1	4495/C	45	245	253,71
00015571	4421/21C	2.5/8		1	4496/C	32	308	738,45



Pg. F-5

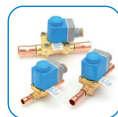

Pg. F-10



Pg. F-15



Pg. G-22



Pg. G-24



## UNIVERSELE SHELLDROGERS MET VERWISSELBARE KERNEN



- 4490/A: Kern voor vloeistofleiding (Model 48-DU/DM) (1)
- 4490/AA: Anti-acid kern (Model 48-DA) (1)
- 4491/A: Kern voor vloeistofleiding (Model 100) (2)
- 4491/AA: Anti-acid kern (Model 100) (2)
- 4495: Mechanisch filterpatroon voor zuigleiding (Model 48-F) (3)
- 4496: Mechanisch filterpatroon voor zuigleiding (Model 100) (3)

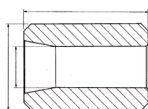

(1)

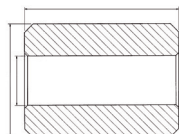

(2)

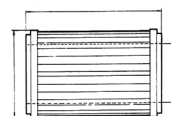

(3)

### Kernen Castel

Art. Nr.	Type	Diam out	Diam in	Lengte	Prijs
		mm	mm	mm	EUR
00010252	4490/A	96	47	140	22,39
00049517	4490/AA	96	47	140	28,00
00015726	4491/A	122	53	165	63,44
00049518	4491/AA	122	53	165	67,16
00010253	4495/C	87	60	138	49,14
00015304	4496/C	113	80	168	88,42

### Onderdelen shelldrogers Castel

Art. Nr.	Type	Omschrijving	Prijs
			EUR
00073850	111758	Kit dichting voor huizen van Danfoss, Alco, Sporlan, KMP, Carly en Henry	15,55
00013122	3319	Veer (voor alle 44.-modellen)	5,69
00048350	3324	Deksel onderaan - Rood (voor 4411A/4412A/4413A/4414A)	9,50
00053358	9406	Deksel bovenaan + schroef - Rood (voor 4411A/4412A/4413A/4414A)	9,59
00061253	9150/R57	Deksels voor onder- en bovenaan (voor 4411/C)	28,27
00068347	9150/R58	Deksels voor onder- en bovenaan (voor 4421/C)	45,23

F

F-6

## UNIVERSELE SHELLDROGERS MET VERWISSELBARE KERNEN

DCR



- Geleverd zonder kernen.
- Koelmiddelen CFC, HCFC & HFC.
- Temperatuurbereik -40°C ~ +70°C.

### Voor vloeistofleiding ODS

Art. Nr.	Type	Code Danfoss	Vol.	Max. werkdruk	Verbinding	Aantal	Prijs
			cm <sup>3</sup>	Bar	Soldeer ODS	Kernen	EUR
00031053	DCR 0485S	023U7250	760	46	5/8"	1	106,00
00031054	DCR 0487S	023U7251	760	46	7/8"	1	106,00
00031070	DCR 0489S	023U7252	760	46	28 mm	1	106,00
00027140	DCR 0489S	023U7253	760	46	1 1/8"	1	106,00
00031055	DCR 04811S	023U7254	760	46	1 3/8"	1	106,00
00031071	DCR 04813S	023U7256	760	46	42 mm	1	106,00
00024760	DCR 04817S	023U7257	760	46	2 1/8"	1	106,00
00031057	DCR 04821S	023U7276	760	46	2 5/8"	1	106,00
00031072	DCR 09613S	023U7263	1520	46	42 mm	2	138,00
00031073	DCR 0969S	023U7259	1520	46	28 mm	2	138,00
00031075	DCR 14413S	023U7269	2280	46	42 mm	3	145,00
00031066	DCR 14417S	023U7270	2280	46	2 1/8"	3	145,00
00031076	DCR 19213S	023U7273	3040	46	42 mm	4	158,00



### Kernen Danfoss

Art. Nr.	Type	Code Danfoss	Omschrijving	Prijs
				EUR
00020020	48-DU/DM	023U1392	Voor R134a, R404A en R407C, HFC	38,20
00027342	48-DA	023U5381	Burn-out filter voor R22, R134a, R404A en R507	38,20
00010173	48-F	023U1921	Voor zuigleiding	66,30
00060948	Set DCR	023U0055	Dichtingen set voor DCR kern	16,10

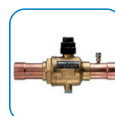

F

F-7

Let op: De prijzen in deze catalogus zijn een momentopname en kunnen wijzigen. De actuele prijzen vindt u steeds op onze webshop.



## CO<sub>2</sub> - FILTERDROGERS

CASTEL



### Filterdrogers - Soldeer

Art. Nr.	Type	Volume	ODS	PS	Prijs
		cm <sup>3</sup>	Inch	bar	EUR
00082738	DF303E/2S	50	1/4"	80	25,45
00082739	DF303E/3S	50	3/8"	80	25,45
00082740	DF305E/2S	80	1/4"	80	28,21
00082741	DF305E/3S	80	3/8"	80	28,21
00089357	DF308E/3S	130	3/8"	80	42,60
00082742	DF308E/4S	130	1/2"	80	42,60
00082743	DF316E/5S	250	5/8"	80	54,04



## CO<sub>2</sub> - FILTERDROGERS

REFRIGERA



### Filterdrogers - Soldeer

Art. Nr.	Type	Volume	ODS	PS	Prijs
		cm <sup>3</sup>	Inch	bar	EUR
00068153	FD00108301038	210	3/8"	60	30,77
00081635	REF77.084.01.127	230	1/2"	60	35,54



## CO<sub>2</sub> - FILTERDROGERS

PARKER



### Filterdrogers - Soldeer

Art. Nr.	Type	Volume	ODS	PS	Prijs
		cm <sup>3</sup>	Inch	bar	EUR
00082592	CO-082-S	200	1/4"	155	266,02

F

F-8

V-26/1/2026

## CO<sub>2</sub> - FILTERDROGER MET VERWISSELBARE KERN

CASTEL



### Filterdrogers met verwisselbare kern - Soldeer

Art. Nr.	Type	ODS	Aantal kernen	Temperatuur bereik	PS	Prijs
		Inch	#	°C		
00081609	4411E/5AF	5/8"	1	-40 .. +80	62	279,15
00081610	4411E/7AF	7/8"	1	-40 .. +80	62	279,15
00081611	4411E/9AF	1.1/8"	1	-40 .. +80	62	286,91
00081612	4411E/11AF	1.3/8"	1	-40 .. +80	62	292,11
00081613	4411E/13AF	1.5/8"	1	-40 .. +80	62	302,43
00081614	4412E/7AF	7/8"	2	-40 .. +80	62	325,69
00081615	4412E/9AF	1.1/8"	2	-40 .. +80	62	333,44
00081616	4412E/11AF	1.3/8"	2	-40 .. +80	62	338,62
00081617	4412E/13AF	1.5/8"	2	-40 .. +80	62	348,95



### Verwisselbare kernen

Art. Nr.	Type	Omschrijving	Volume	Prijs
			cm <sup>3</sup>	
00081619	4490/AB	80 % moleculair - 20 % aluminium	800	25,20
00071087	4490/B	100 % moleculair	800	19,60



00089195



00061253



00010253

### Onderdelen

Art. Nr.	Type	Omschrijving	Prijs
			EUR
00089195	111135	Dichting voor filterdrogers met verwisselbare kern	11,38
00061253	9150/R57	Ombouwwkit voor mechanische filter	28,27
00010253	4495/C	Mechanische filter - Volume 820 cm <sup>3</sup>	49,14

## STRAINER CO<sub>2</sub>

CASTEL



### Strainer

Art. Nr.	Code	Soldeer aansluiting	Filter oppervlak	Kv-factor	Temp. bereik	PS	Prijs
		Inch	cm <sup>2</sup>				
00082579	4727E/3	3/8" ODS	13	2,00	-40 .. +140	120	187,01
00088475	4727E/4	1/2" ODS	13	2,50	-40 .. +140	120	187,01
00088477	4727E/5	5/8" ODS	13	3,00	-40 .. +140	120	187,01
00088798	4727E/6	3/4" ODS	18	6,00	-40 .. +140	120	187,01
00088476	4727E/7	7/8" ODS	18	6,00	-40 .. +140	120	187,01
00088478	4727E/9	1.1/8" ODS	18	6,00	-40 .. +140	120	223,25
00088479	4727E/11	1.3/8" ODS	31	7,00	-40 .. +140	120	297,78

Let op: De prijzen in deze catalogus zijn een momentopname en kunnen wijzigen. De actuele prijzen vindt u steeds op onze webshop.

V-26/1/2026



Pg. F-2



Pg. F-5



Pg. F-15



## MAGNEETVENTIELEN NC (NORMAAL GESLOTEN)

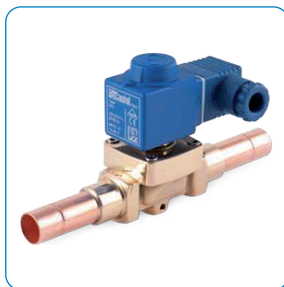

- Max werkdruk 45 Bar.
- Geleverd met spoel 240V 50Hz, (Behalve model S).
- Koelcapaciteiten T<sub>evap</sub> = +4°C; T<sub>cond</sub> = +38°C.
- Ook toepasbaar voor R410A.
- Capaciteiten opgegeven bij vloeistofleiding.
- DIR = direct.
- DIA = diafragma piloot gestuurd.
- PIS = pistonpiloot gestuurd.

### Flare

Art. Nr	Type	Aansluiting		Openingsdruk		Lengte	R134a	R410A	R407C	R404A	Prijs
				bar Min./Max.	m <sup>3</sup> /u						
00107321	1020/2	1/4" SAE	DIR	0 / 21	0,18	58	2,95	3,00	3,28	2,08	59,66
00107322	1020N/3A6	3/8" SAE	DIR	0 / 21	0,23						0,00
00107323	1064/3	3/8" SAE	DIA	0,05 / 21	0,80	68	6,80	10,90	9,50	7,70	0,00
00107326	1070N/5A6	5/8" SAE	DIA	0,05 / 21	2,61	106	44,00	44,80	45,00	31,10	124,85
00107327	1090N/5A6	5/8" SAE	DIA	0,05 / 21	3,80	120	37,40	37,80	37,90	26,20	186,88
00107328	1090N/6A6	3/4" SAE	DIA	0,05 / 21	4,80	124	44,40	44,80	45,00	31,10	196,15

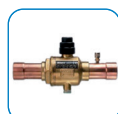

Pg. F-18



Pg. G-22



Pg. G-24

### Soldeer

Art. Nr	Type	Aansluiting		Openingsdruk		Lengte	R134a	R410A	R407C	R404A	Prijs
				bar Min./Max.	m <sup>3</sup> /u						
00098038	1028N/2A6	1/4" ODS	DIR		0,23						65,42
00098039	1028N/3A6	3/8" ODS	DIR		0,23						70,20
00098040	1068N/3A6	3/8" ODS	DIA	0,05 / 21	0,80	111	13,60	13,70	13,80	9,50	92,25
00098041	1068N/4A6	1/2" ODS	DIA	0,05 / 21	0,80	127	13,60	13,70	13,80	9,50	96,66
00098042	1078N/4A6	1/2" ODS	DIA								124,63
00098043	1078N/5A6	5/8" ODS	DIA	0,05 / 21	2,61	175	44,00	44,80	45,00	31,10	149,91
00098046	1098N/6A6	3/4" ODS	DIA								216,02
00098047	1098N/7A6	7/8" ODS	DIA	0,05 / 21	5,70	180	96,00	97,90	98,20	67,80	223,48
00098049	1078N/9A6	1 1/8" ODS	DIA								569,34
00098048	1099N/9A6	1 1/8" ODS	DIA								276,15
00098050	1079N/11A6	1 3/8" ODS	DIA								596,95
00107324	1064N/4A6	1/2" ODS	DIA	0,05 / 21	0,80	72	13,50	13,70	15,00	9,50	85,98

F

F-10

Let op: De prijzen in deze catalogus zijn een momentopname en kunnen wijzigen. De actuele prijzen vindt u steeds op onze webshop.



9300/RA

### Spoelen zonder kabel

Art. Nr.	Type	Spanning	Spoel	Vermogen	Prijs
		V	type	W	
00076087	9300/RA7	240 V - 50/60 Hz	HF2	8	21,66
00076084	9300/RA2	24 V - 50/60 Hz	HF2	8	21,66
00076088	9320/RA6	220/230 V - 50/60 Hz	HF3	12	55,41
00076089	9320/RD1	12VDC	HF3	20	50,91
00076090	9320/RD2	24VDC	HF3	20	50,91



PG11

### Aansluitconnector met of zonder kabel

Art. Nr.	Type	Type spoel	Kabel	Prijs
			m	
00015061	9150/R02	PG11	-	3,19
00016551	9900/X66	PG111	1	10,49
00060272	9900/X73	PG112	2	13,71
00063713	9900/X55	PG113	3	18,36
00051855	9900/X54	PG115	5	23,96

### Repair kits magneetventielen

Art. Nr	Type	Omschrijving	Prijs
			EUR
00013872	9150/R07	1020/2 -/3 -- 1028/2 -/3	45,23
00013873	9150/R08	1064/3 -/4 -- 1068/3 -/4 + 1098/9 -- 1099/11 -- 1078/11 -/13 -- 1079/13 -/17	75,69
00012326	9150/R09	1070/4 -/5 -- 1078/4 -/5 -- 1079/7	92,87
00061923	9151/R04	1090/5 -/6 -- 1098/5 -/6 -/7 -- 1099/9	63,28
00012332	9150/R11	1078/9 -- 1079/11	205,59
00049504	9150/R39	1078/11 -- 1079/13 -- 1178/11	161,03
00061196	9150/R43	1098/9 -- 1099/11 -- 1198/9	172,50

## MAGNEETVENTIELEN



- Capaciteiten opgegeven voor vloeistofleiding.
- Geleverd zonder spoel.
- Maximale werkdruk: 45,2 bar.
- Koelmiddelen: CFC, HCFC, HFC.
- Temperatuur van het medium: -40 ~ +105°C (10W / 12W spoel).
- Maximum 130°C tijdens ontdooiing.

### Soldeer

Art. Nr	Type	Code Danfoss	Aansluiting	R407C	R134a	R404A	Min. dP	Kv Factor	Prijs
				kW	kW	kW		Bar	
00060895	EVR2 - NC	032F8056	1/4"				0,00	0,16	85,60
00000642	EVR3 - NC	032F8116	3/8"				0,00	0,27	107,00
00053535	EVR3 - NC	032F8107	1/4"				0,00	0,27	107,00
00060615	EVR3 - NC	032F8105	1/4"				0,00	0,27	107,00
00082851	EVR6 - NO	032L8085	3/8"				0,03	1,00	234,00
00082875	EVR6 - NC	032L8079	1/2"				0,03	1,00	150,00
00082876	EVR6 - NC	032L8072	3/8"				0,03	1,00	150,00
00082855	EVR10 - NC	032L8095	1/2"				0,03	2,20	197,00
00082859	EVR15 - NC	032L8101	5/8"				0,03	3,30	334,00

Let op: De prijzen in deze catalogus zijn een momentopname en kunnen wijzigen. De actuele prijzen vindt u steeds op onze webshop.

V-26/1/2026

## Soldeer



Pg. F-2



Pg. F-5



Pg. F-15



Pg. F-18



Pg. G-22



Pg. G-24



F

F-12

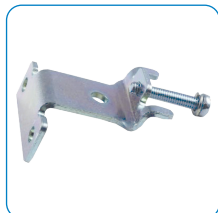

Art. Nr	Type	Code Danfoss	Aansluiting	R407C kW	R134a kW	R404A kW	Min. dP Bar	Kv Factor m <sup>3</sup> /u	Prijs EUR
00000638	EVR2 - NC	032F1201	1/4"				0,00	0,16	86
00000641	EVR3 - NC	032F1206	1/4"				0,00	0,27	107
00000643	EVR3 - NC	032F1204	3/8"				0,00	0,27	107
00082853	EVR6 - NC	032L1212	3/8"				0,03	1,00	150
00082852	EVR6 - NO	032L1290	3/8"				0,03	1,00	234
00082854	EVR6 - NC	032L1209	1/2"				0,03	1,00	150
00082880	EVR6 - NC	032L7117	5/8"				0,03	1,00	150
00082856	EVR10 - NC	032L1217	1/2"				0,03	2,20	197
00082858	EVR10 - NC	032L1214	5/8"				0,03	2,20	197
00082877	EVR10 - NO	032L1291	1/2"				0,03	2,20	266
00082860	EVR15 - NC	032L1227	5/8"				0,03	3,30	394
00082862	EVR15 - NC	032L1228	5/8"				0,03	3,30	334
00082861	EVR15 - NO	032L1299	5/8"				0,03	3,30	403
00082863	EVR15 - NC	032L1225	7/8"				0,03	3,30	334
00082878	EVR15 - NO	032L3270	7/8"				0,03	3,30	403
00082864	EVR20 - NC	032L1240	7/8"				0,03	6,00	440
00082865	EVR20 - NC	032L1244	1.1/8"				0,03	6,00	440
00082866	EVR20 - NO	032L1269	1.1/8"				0,03	6,00	507
00082867	EVR22 - NC	032L3267	1.3/8"				0,03	6,00	488
00082874	EVR22 - NO	032L3268	1.3/8"				0,03	6,00	541
00082868	EVR25 - NC	032L2201	1.1/8"				0,20	9,80	789
00082869	EVR25 - NC	032L2208	1.3/8"				0,20	9,80	789
00082870	EVR32 - NC	032L1106	1.3/8"				0,20	16,70	1 150
00082871	EVR32 - NC	032L1104	1.5/8"				0,20	16,70	1 150
00082872	EVR40 - NC	032L1110	1.5/8"				0,20	24,20	1 340

## Spoelen Danfoss

Art. Nr	Code Danfoss	Vermogen W	IP klasse	Kabel	Voeding	Prijs EUR
00092198	042N0842	7,5 - 5,5	IP00	-	24 VAC	26,40
00027158	018F6176	10	IP20	-	230 Vac	60,90
00006693	018F6732	10	IP67	-	220-230 Vac	78,90
00006657	018F6701	10	IP67	-	220-230 Vac	78,90
00006658	018F6251	10	IP67	1m	220-230 Vac	77,10
00006680	018F6707	10	IP67	-	24 Vac	78,90
00006684	018F6702	10	IP67	-	240 Vac	78,90
00073784	018F7351	11	IP00	-	230 Vac	34,60
00006659	018F6801	12	IP67	-	220-230 Vac	94,30
00006696	018F6802	12	IP67	-	240 Vac	94,30
00013780	042N7550	14	IP00	-	12 Vdc	41,10
00063766	018F7363	16 - 13	IP00	-	230 Vac	0,00
00077139	018F6991	18	IP00	-	230 Vac	65,10
00105484	018F6905	19	IP67	-	230 Vac	103,00
00006701	018F6856	20	IP67	-	12 Vdc	94,30
00006705	018F6887	20	IP67	-	24 Vdc	94,30

## Montagevoet Danfoss

Art. Nr	Code Danfoss	Omschrijving	Prijs EUR
00060474	032F0197	Montagevoet voor Danfoss magneetventiel voor EVR2/10	8,90

## TERUGSLAGKLEPPEN

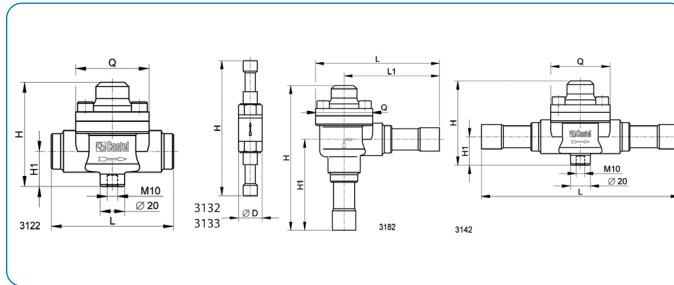
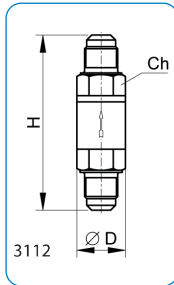

- Koelcapaciteiten in vloeistoffase  
 $T_o = 4^{\circ}\text{C}; T_c = +38^{\circ}\text{C}$
- Hor.: montage dient horizontaal te gebeuren, flens plat monteren.
- Vert.: verticale montage, pijl naar boven.
- 90°: ingang terugslagklep naar beneden.



### Flare

Art. Nr	Type	Aansluiting	Montage	Min. Dp	Kv Factor	Lengte	R134a	R410A	R407C	R404a	Prijs
				Bar	m <sup>3</sup> /h	mm	kW	kW	kW	kW	
00082882	3112W/3	3/8" SAE	Vert.	0,10	1,50	H:68	25,50	25,80	25,80	17,90	32,68
00082883	3112W/4	1/2" SAE	Vert.	0,10	1,80	H:73	30,60	30,90	31,00	21,40	32,84
00082884	3112W/5	5/8" SAE	Vert.	0,10	3,30	H:85	56,10	56,70	56,90	39,30	50,39
00082885	3112W/6	3/4" SAE	Vert.	0,10	5,00	H:98	85,00	85,90	86,20	59,50	52,41

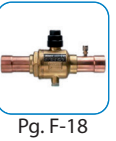

### Soldeer

Art. Nr	Type	Aansluiting	Montage	Min. Dp	Kv Factor	Lengte	R134a	R410A	R407C	R404a	Prijs
				Bar	m <sup>3</sup> /h	mm	kW	kW	kW	kW	
00082887	3132W/3	3/8" ODS	Vert.	0,04	1,50	H:107	25,50	25,80	25,80	17,90	42,52
00082888	3132W/4	1/2" ODS	Vert.	0,04	1,80	H:132	30,30	30,90	31,00	21,40	43,31
00082889	3132W/5	5/8" ODS	Vert.	0,04	3,30	H:139	56,10	56,70	56,90	39,30	61,18
00082890	3132W/6	3/4" ODS	Vert.	0,04	5,00	L:165	85,00	85,90	86,20	59,50	66,58
00107424	3124N/7	7/8" ODS	Hor.	0,04	8,10	H:96	138,00	139,00	140,00	96,00	123,98
00082891	3132W/7	7/8" ODS	Vert.	0,1	5,00	H:165	85,00	85,90	86,20	59,50	75,84
00029346	3122/9	1 1/8" ODS	Hor.	0,1	8,80	L:100	149,60	151,10	151,60	104,70	141,96
00107426	3124N/11	1 3/8" ODS	Hor.	0,1	15,20	L:118	258,40	261,00	261,90	180,90	181,30
00107427	3124N/13	1 5/8" ODS	Hor.	0,04	27,00		459,00	464,00	465,00	321,00	305,90



### Spare parts: (bevat zuiger, veer, dichting en schroeven)

Art. Nr	Type	Spare part voor type	Prijs
			EUR
00013874	KIT 9150/R16	3120/7 -9	Dichting = O-ring 95,42
00013876	KIT 9150/R17	3120/11	Dichting = O-ring 118,68
00013878	KIT 9150/R18	3120/13	Dichting = O-ring 162,83
00048047	KIT 9150/R52	3122/7-9; 3142/7-9; 3182/7-9	Dichting = in metaal 93,59
00048048	KIT 9150/R53	3122/11 - 3142/11 - 3182/11	Dichting = in metaal 146,88
00048050	KIT 9150/R54	3122/13; 3142/13	Dichting = in metaal 160,05
00048051	KIT 9150/R55	3122/17 -- 3142/17-21-25 -- 3182/13-17	Dichting = in metaal 195,71



Pg. F-2



Pg. F-5



Pg. F-15



Pg. F-18



Pg. G-22



Pg. G-24

**Danfoss**

**TERUGSLAGKLEPPEN**



Recht flare



Haaks soldeer



Recht soldeer

- Max. werkdruk: 46 bar
- Mediumtemperatuur: -50 / +140°C

**Rechte terugslagklep**

Art. Nr	Type	Code Danfoss	Aansl.	Kv-waarde	Min. Dp	Prijs
				m <sup>3</sup> /u	Bar	
00005839	NRV6	020-1040	1/4" Flare	0,560	0,07	41,70
00005889	NRV10	020-1041	3/8" Flare	1,430	0,07	47,90
00005890	NRV12	020-1042	1/2" Flare	2,050	0,05	52,10
00005891	NRV16	020-1043	5/8" Flare	3,600	0,05	66,70
00005892	NRV19	020-1044	3/4" Flare	5,500	0,05	87,50
00005846	NRV6S	020-1010	1/4" ODS	0,560	0,07	39,00
00005893	NRV6S	020-1057	3/8" ODS	0,560	0,07	39,00
00005894	NRV10S	020-1011	3/8" ODS	1,430	0,07	43,20
00005895	NRV10S	020-1058	1/2" ODS	1,430	0,07	47,50
00005896	NRV12S	020-1012	1/2" ODS	2,050	0,05	46,10
00005898	NRV12S	020-1052	5/8" ODS	2,050	0,05	50,70
00005899	NRV16S	020-1018	5/8" ODS	3,600	0,05	58,50
00005900	NRV16S	020-1059	3/4" ODS	3,600	0,05	64,30
00005901	NRV19S	020-1019	3/4" ODS	5,500	0,05	76,60
00005902	NRV19S	020-1054	7/8" ODS	5,500	0,05	84,30

**Haakse terugslagklep**

00005903	NRV22S	020-1020	7/8" ODS	8,500	0,04	122,00
00005904	NRV22S	020-1060	1 1/8" ODS	8,500	0,04	134,00
00005905	NRV28S	020-1021	1 1/8" ODS	19,000	0,04	209,00
00005906	NRV28S	020-1056	1 3/8" ODS	19,000	0,04	230,00
00005907	NRV35S	020-1026	1 3/8" ODS	29,000	0,04	265,00
00005908	NRV35S	020-1061	1 5/8" ODS	29,000	0,04	292,00

**Rechte terugslagklep met versterkte veer**

00005909	NRVH6S	020-1069	3/8" ODS	0,560	0,30	47,90
00005910	NRVH10S	020-1046	3/8" ODS	1,430	0,30	53,20
00005911	NRVH10S	020-1070	1/2" ODS	1,430	0,30	58,50
00005912	NRVH12S	020-1039	1/2" ODS	2,050	0,30	56,60
00005913	NRVH12S	020-1064	5/8" ODS	2,050	0,30	62,30
00005914	NRVH16S	020-1038	5/8" ODS	3,600	0,30	71,90
00005915	NRVH16S	020-1071	3/4" ODS	3,600	0,30	79,10
00005916	NRVH19S	020-1023	3/4" ODS	5,500	0,30	94,20
00005917	NRVH19S	020-1066	7/8" ODS	5,500	0,30	104,00

**Haakse terugslagklep met versterkte veer**

00005918	NRVH22S	020-1032	7/8" ODS	8,500	0,30	125,00
00005919	NRVH22S	020-1072	1 1/8" ODS	8,500	0,30	138,00
00005920	NRVH28S	020-1029	1 1/8" ODS	19,000	0,30	215,00
00005921	NRVH28S	020-1068	1 3/8" ODS	19,000	0,30	236,00
00005922	NRVH35S	020-1034	1 3/8" ODS	29,000	0,30	273,00
00005923	NRVH35S	020-1073	1 5/8" ODS	29,000	0,30	301,00

Een terugslagklep met versterkte veer is enkel nodig indien er meerdere compressoren parallel staan op een centrale en iedere compressor een terugslagklep heeft.

**F**

F-14

Let op: De prijzen in deze catalogus zijn een momentopname en kunnen wijzigen. De actuele prijzen vindt u steeds op onze webshop.

## KIJKGLAZEN MET VOCHTAANDUIDER



### FLARE aansluiting

Art. Nr.	Type	Aansluiting	Aansluiting	PS bar	Prijs EUR
		Type	Flare		
00053986	3950/22	M/F	1/4"	45	23,45
00054326	3950/33	M/F	3/8"	45	25,21
00054327	3950/44	M/F	1/2"	45	28,38
00000736	3950/55	M/F	5/8"	45	39,68
00000737	3950/66	M/F	3/4"	45	68,79
00053930	3910/33	M/M	3/8"	45	23,23
00000723	3910/44	M/M	1/2"	45	27,80
00000724	3910/55	M/M	5/8"	45	29,03
00000725	3910/66	M/M	3/4"	45	39,41



### ODS soldeer aansluiting

Art. Nr.	Type	Aansluiting	Aansluiting	PS bar	Prijs EUR
		Type	Flare		
00054533	3940/2	F/F	1/4"	45	29,62
00054428	3940/3	F/F	3/8"	45	32,13
00000727	3940/4	F/F	1/2"	45	33,41
00054534	3940/5	F/F	5/8"	45	36,84
00000729	3940/6	F/F	3/4"	45	44,37
00000730	3940/7	F/F	7/8"	45	60,85
00054008	3940/9	F/F	1 1/8"	45	74,47
00025831	3770/11	F/F	1 3/8" ODM	35	72,22



Pg. F-2



Pg. F-5



Pg. F-10



Pg. G-22



Pg. G-24

F

F-15

Let op: De prijzen in deze catalogus zijn een momentopname en kunnen wijzigen. De actuele prijzen vindt u steeds op onze webshop.



Pg. F-2



Pg. F-5



Pg. F-10

**Danfoss**

**KIJKGLAZEN**



- Maximale werkdruk 52 Bar.
- Geschikt voor alle HCFC's en niet-brandbare HFC's en HC.
- Corrosie vrije body.
- Omgevingstemperatuur -50°C ~ +80°C.

**FLARE aansluiting**

Art. Nr.	Type	Code Danfoss	Aansluiting		Prijs
			Type	Flare	
00071514	SGP6N	014L0161	M/M	1/4"	48,30
00071515	SGP10N	014L0162	M/M	3/8"	54,10
00071509	SGP12N	014L0163	M/M	1/2"	58,90
00071516	SGP16N	014L0165	M/M	5/8"	77,20
00071517	SGP19N	014L0166	M/M	3/4"	114,00
00071518	SGP6N	014L0171	M/F	1/4"	48,30
00071519	SGP10N	014L0172	M/F	3/8"	54,10
00071520	SGP12N	014L0173	M/F	1/2"	58,90
00071521	SGP16N	014L0174	M/F	5/8"	77,20
00071522	SGP19N	014L0175	M/F	3/4"	114,00

**ODS soldeer aansluiting**

Art. Nr.	Type	Code Danfoss	Aansluiting		Prijs
			type	Soldeer	
00071524	SGP6SN	014L0181	F/F	1/4"	56,80
00071508	SGP10SN	014L0182	F/F	3/8"	61,30
00071510	SGP12SN	014L0183	F/F	1/2"	66,50
00071523	SGP16SN	014L0184	F/F	5/8"	88,00
00071511	SGP19SN	014L0185	F/F	3/4"	114,00
00071512	SGP22SN	014L0186	F/F	7/8"	139,00
00071529	SGP22SN	014L0187	F/F	1.1/8"	139,00
00071513	SGP6SN	014L0201	M/F	1/4"	56,80
00071526	SGP10SN	014L0202	M/F	3/8"	61,30
00071527	SGP12SN	014L0203	M/F	1/2"	66,50
00071528	SGP16SN	014L0204	M/F	5/8"	88,00
00071525	SGP22SN	014L0206	M/F	7/8"	139,00



Pg. G-22



Pg. G-24

**F**

F-16

V-26/1/2026

Let op: De prijzen in deze catalogus zijn een momentopname en kunnen wijzigen. De actuele prijzen vindt u steeds op onze webshop.

## CO<sub>2</sub> KIJKGLAZEN

CASTEL



### Kijkglas - Soldeer - 60 bar

Art. Nr.	Type	ODS	PS	Prijs
		Inch	bar	EUR
00081587	3940EL/2	1/4"	60	32,90
00081588	3940EL/3	3/8"	60	35,69
00081589	3940EL/4	1/2"	60	37,11
00081590	3940EL/5	5/8"	60	40,88
00081591	3940EL/6	3/4"	60	49,26
00081592	3940EL/7	7/8"	60	70,39
00081593	3940EL/9	1.1/8"	60	91,55



### Kijkglas - Soldeer - 80 bar

Art. Nr.	Type	ODS	PS	Prijs
		Inch	bar	EUR
00081594	3740E/2	1/4"	80	48,86
00081595	3740E/3	3/8"	80	50,63
00081596	3740E/4	1/2"	80	52,72
00081597	3740E/5	5/8"	80	57,96
00081598	3740E/6	3/4"	80	67,55
00081599	3740E/7	7/8"	80	93,39
00081600	3740E/9	1.1/8"	80	118,95



### Kijkglas - Soldeer - 120 bar

Art. Nr.	Type	ODS	PS	Prijs
		Inch	bar	EUR
00081601	3747E/2	1/4"	120	58,96
00081602	3747E/3	3/8"	120	58,96
00081603	3747E/4	1/2"	120	61,29
00081604	3747E/5	5/8"	120	67,57
00081605	3747E/6	3/4"	120	90,46
00081606	3747E/7	7/8"	120	129,24
00081607	3747EE9	1.1/8"	120	208,06

## SERVICE FILTERS

REFCO

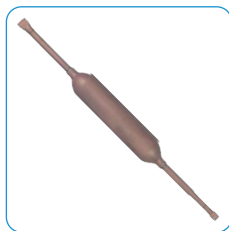

### STU service filters

Art. Nr.	Type	Inhoud	Lengte	Prijs
		gram	mm	EUR
00006865	STU-15	15	250	19,33
00006866	STU-20	20	245	23,88
00006868	STU-30	30	235	23,50

V-26/1/2026

F

F-17



Pg. F-22



Pg. F-23



## BOLKRANEN OP MONTAGEVOET MET SCHRAEDERAANSLUITING

**NEW!**



6570/..A

- Koelmiddelen HFC, CFC, HCFC
- Gelast huis
- Met schraederaansluiting
- Max. werkdruk: 45 bar
- 6590: full port: volledige doorgang op diameter
- 6591: oversized diameters

### Bolkraan op montagevoet

Art. Nr	Type	Aansluiting	Kv Factor	Lengte	Prijs
		soldeer			
		Inch	m <sup>3</sup> /u	mm	EUR
00073549	6570/2A	1/4	0,80	121,00	52
00073545	6570/3A	3/8	3,00	121,00	57
00073544	6570/4A	1/2	5,00	121,00	57
00073543	6570/5A	5/8	17,00	139,00	68
00073546	6570/6A	3/4	17,00	139,00	68
00073547	6570/7A	7/8	29,00	175,00	90
00073548	6570/9A	1.1/8	51,00	204,00	117
00025984	6590/11A	1.3/8	86,00	210,00	170
00025985	6590/13A	1.5/8	117,00	239,00	276
00025986	6590/17A	2.1/8	214,00	275,00	393
00081929	6571/25A	3.1/8	380,00	363,00	1 027
00081930	6571/29A	3.5/8	550,00	381,50	1 560
00081932	6570/29A	3.5/8	710,00	373,00	1 764
00081931	6571/33A	4.1/8	660,00	405,00	1 841

**F**

F-18



## BOLKRANEN OP MONTAGEVOET



- Handbediende, bidirectionele afsluiter.
- Koelmiddelen: HFC, CFC, HCFC.
- Temperatuursbereik GBC6S - GBC42S: -40°C ~ +150°C.  
GBC54S - GBC79S RP: -40°C ~ +121°C.
- Maximum werkdruk: 45 bar.
- Zonder schraederaansluiting.
- RP = oversized diameters.

### Bolkraan op montagevoet GBC zonder schraederaansluiting

Art. Nr	Type	Code Danfoss	Aansluiting	Kv Factor	Prijs
			Soldeer	m <sup>3</sup> /u	
					EUR
00000750	GBC6S	009G7020	1/4"	1,96	43,60
00023440	GBC10S	009G7021	3/8"	5,68	43,80
00041008	GBC12S	009G7022	1/2"	10,58	45,40
00023441	GBC16S	009G7023	5/8"	14,11	47,50
00054733	GBC18S	009G7024	3/4"	20,42	63,10
00023442	GBC22S	009G7025	7/8"	28,17	71,50
00027878	GBC28S	009G7026	1 1/8"	51,95	101,00
00000764	GBC35S	009G7027	1 3/8"	80,89	164,00
00000766	GBC42S	009G7028	1 5/8"	121,07	211,00
00023727	GBC54S	009G7029	2 1/8"	224,96	324,00
00055822	GBC67S RP	009G7036	2 5/8"	245,78	379,00
00025278	GBC79S RP	009G7037	3 1/8"	222,52	555,00

Let op: De prijzen in deze catalogus zijn een momentopname en kunnen wijzigen. De actuele prijzen vindt u steeds op onze webshop.

V-26/1/2026



- Handbediende, bidirectionele afsluiter.
- Koelmiddelen: HFC, CFC, HCFC.
- Temperatuursbereik GBC6S - GBC42S: -40°C ~ +150°C.  
GBC54S - GBC79S RP: -40°C ~ +121°C.
- Maximum werkdruk: 45 bar.
- Met schraederaansluiting.
- RP = oversized diameters.

#### Bolkraan op montagevoet GBC met schraeder

Art. Nr	Type	Code Danfoss	Aansluiting		Kv Factor	Prijs
			Soldeer	m <sup>3</sup> /u		
00090935	GBC6S	009L7050	1/4"	1,96	1,96	52,40
00026552	GBC10S	009G7051	3/8"	5,68	5,68	52,50
00026553	GBC12S	009G7052	1/2"	10,58	10,58	54,50
00090934	GBC16S	009L7053	5/8"	14,11	14,11	57,00
00094148	GBC18S	009L7054	3/4"	20,42	20,42	75,70
00028789	GBC22S	009G7055	7/8"	28,17	28,17	85,80
00094149	GBC28S	009L7056	1 1/8"	51,95	51,95	122,00
00027880	GBC42S	009G7058	1 5/8"	121,07	121,07	253,00
00052708	GBC67S RP	009G7066	2 5/8"	245,78	245,78	454,00
00055823	GBC79S RP	009G7067	3 1/8"	222,52	222,52	666,00



Pg. F-2



Pg. F-5



Pg. F-15

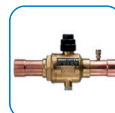

Pg. F-18



Pg. G-22



Pg. G-24

## BOLKRAAN MET OVERDRUKVENTIEL

PARKER



- Bolkraan met geïntegreerd overdrukventiel.
- Bescherming van het systeem tegen overdrukken bij service.
- Bi-directioneel.
- Maximum werkdruk 70 bar.
- -40°C tot +149°C.

#### Bolkraan met geïntegreerd overdrukventiel

Art. Nr	Type	Aansluiting		PS	Prijs
		Soldeer	m <sup>3</sup> /u		
00090605	EBV-PR1030	3/8"	4,30	70	143,92
00090393	EBV-PR1040	1/2"	7,00	70	145,97
00090392	EBV-PR1050	5/8"	13,90	70	147,17
00090629	EBV-PR1070	7/8"	30,30	70	190,48
00090630	EBV-PR1090	1.1/8"	61,30	70	244,89

F

F-19



## CO<sub>2</sub> BOLKRAAN

CASTEL



### Bolkraan - Soldeer - 60 bar

Art. Nr.	Type	ODS	Doorlaat	Kv-waarde	PS	Prijs
		Inch	mm	m <sup>3</sup> /u	bar	
00081545	6570EL/2	1/4"	10	0,80	60	45,91
00081546	6570EL/3	3/8"	10	3,00	60	46,55
00081547	6570EL/4	1/2"	10	5,00	60	46,55
00081548	6570EL/5	5/8"	15	17,00	60	69,67
00081549	6570EL/6	3/4"	15	17,00	60	69,67
00081550	6570EL/7	7/8"	19	29,00	60	94,11
00081551	6570EL/9	1.1/8"	25	51,00	60	126,31
00081552	6590EL/11	1.3/8"	32	86,00	60	155,71
00081553	6590EL/13	1.5/8"	38	117,00	60	243,39
00081554	6590EL/17	2.1/8"	50	214,00	60	369,51



### Bolkraan - Soldeer - 80 bar

Art. Nr.	Type	ODS	Doorlaat	Kv-waarde	PS	Prijs
		Inch	mm	m <sup>3</sup> /u	bar	
00081555	6570E/2	1/4"	10	0,80	80	71,13
00081556	6570E/3	3/8"	10	3,00	80	72,11
00081557	6570E/4	1/2"	10	5,00	80	72,11
00081558	6570E/5	5/8"	15	17,00	80	88,48
00081559	6570E/6	3/4"	15	17,00	80	88,48
00081560	6570E/7	7/8"	19	29,00	80	119,54
00081561	6570E/9	1.1/8"	25	51,00	80	160,43
00081562	6590E/11	1.3/8"	32	86,00	80	197,92

### Bolkraan - Soldeer - 90 bar

Art. Nr.	Type	ODS	Doorlaat	Kv-waarde	PS	Prijs
		Inch	mm	m <sup>3</sup> /u	bar	
00107272	6531E/3A	3/8"	15	3,00	90	150,29
00107273	6531E/4A	1/2"	15	5,00	90	159,60
00107274	6531E/5A	5/8"	15	17,00	90	163,59
00107275	6531E/6A	3/4"	15	17,00	90	186,20
00107276	6531E/7A	7/8"	19	29,00	90	200,83
00107277	6531E/9A	1.1/8"	19	29,00	90	244,72

### Bolkraan - Soldeer - 120 bar

Art. Nr.	Type	ODS	Doorlaat	Kv-waarde	PS	Prijs
		Inch	mm	m <sup>3</sup> /u	bar	
00081564	6577E/2	1/4"	10	0,80	120	76,28
00081565	6577E/3	3/8"	10	3,00	120	84,78
00081566	6577E/4	1/2"	10	5,00	120	101,74
00081567	6577E/5	5/8"	15	17,00	120	118,67
00081568	6577E/6	3/4"	15	17,00	120	118,67
00081569	6597E/7	7/8"	19	29,00	120	182,99
00081570	6597E/9	1.1/8"	25	51,00	120	283,07
00081572	6597E/13	1.5/8"	38	117,00	120	475,46
00081573	6597E/17	2.1/8"	50	214,00	120	740,29



F

F-20

Let op: De prijzen in deze catalogus zijn een momentopname en kunnen wijzigen. De actuele prijzen vindt u steeds op onze webshop.

## CO<sub>2</sub> BOLKRAAN

REFRIGERA



### Bolkraan - Soldeer - 60 bar

Art. Nr.	Type	ODS	Doorlaat	Kv-waarde	PS	Prijs
		Inch	mm	m <sup>3</sup> /u	bar	EUR
00068138	BV21F158R0000	1.5/8"	40	98,00	52	313,97

### Bolkraan - Soldeer - 120 bar

Art. Nr.	Type	ODS	Doorlaat	Kv-waarde	PS	Prijs
		Inch	mm	m <sup>3</sup> /u	bar	EUR
00081647	BV21Z014R0005	1/4"	8	1,00	120	74,03
00081648	BV21Z038K0000	3/8"	8	2,40	120	84,77
00081649	BV21Z012K0000	1/2"	8	2,70	120	84,77
00081650	BV21B016K0000	5/8"	15	13,00	120	146,11
00081651	REF1.1.N.B.034.K65	3/4"	15	14,00	120	148,32
00081652	REF1.1.N.C.022.K65	7/8"	19	24,00	120	180,83
00091252	BV21D118K0005	1.1/8"	22	40,00	120	244,44
00081654	BV21E035K0000	1.3/8"	28	67,30	120	321,47
00081655	BV21F158K0000	1.5/8"	38	98,00	120	484,60

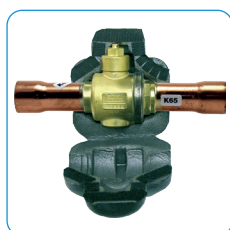

### Isolatie voor bolkraan 1/4" - 3/8" - 1/2" zonder schraeder

Art. Nr.	Type	Omschrijving	Prijs
			EUR
00068159	REF90.VS.06.125.Z	Optimale isolatie, geschikt voor 1/4", 3/8" en 1/2" (zonder schraeder)	17,20



### Bolkraan - Soldeer met schraeder - 60 bar

Art. Nr.	Type	ODS	Doorlaat	Kv-waarde	PS	Prijs
		Inch	mm	m <sup>3</sup> /u	bar	EUR
00081621	REF1.1.S.A.010.2.60	3/8"	8	2,40	60	67,93
00081622	REF1.1.S.A.012.2.60	1/2"	8	2,70	60	70,04
00081623	SV21B016R0000	5/8"	15	13,00	60	98,96
00081625	SV21C022R0000	7/8"	19	24,00	60	137,34
00081626	SV21D118K0008	1.1/8"	25	40,00	60	202,28

### Bolkraan - Soldeer met schraeder - 120 bar

Art. Nr.	Type	ODS	Doorlaat	Kv-waarde	PS	Prijs
		Inch	mm	m <sup>3</sup> /u	bar	EUR
00081656	SV21A014R0005	1/4"	8	1,00	120	81,99
00081657	SV21A038K0000	3/8"	8	2,40	120	99,04
00081658	SV21A012K0000	1/2"	8	2,70	120	107,85
00081659	SV21B016K0000	5/8"	15	13,00	120	157,18
00081660	SV21B034K0000	3/4"	15	14,00	120	161,61

F

F-21



Pg. F-18



## HANDAFSLUITERS (MEMBRAAN)



6210/.



6220/.

- Toegelaten temperatuursbereik: -35 ~ +90°C.
- Maximum toegelaten werkdruk: 28 bar.

### Handafsluiters

Art. Nr.	Type	Aansluiting		Kv Factor	Lengte	Prijs
		Flare	Soldeer			
00000658	6210/2	1/4"	-	0,28	58	37,65
00000705	6210/3	3/8"	-	1,00	74	48,14
00000706	6210/4	1/2"	-	1,30	78	51,34
00000707	6210/5	5/8"	-	1,80	78	57,75
00000708	6210/6	3/4"	-	3,65	98	84,89
00000651	6220/2	-	1/4"	0,28	53	37,85
00000700	6220/3	-	3/8"	1,00	61	47,92
00000701	6220/4	-	1/2"	1,30	70	51,34
00000702	6220/5	-	5/8"	1,80	71	57,75
00000703	6220/6	-	3/4"	3,65	92	84,89
00000704	6220/7	-	7/8"	3,65	94	93,34



## MEMBRAANAFSLUITERS MET AFDEKKAP



6410/.

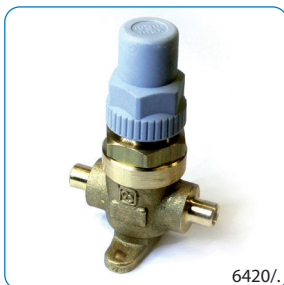

6420/.

- Toegelaten temperatuursbereik: -60 ~ +110°C.
- Maximum toegelaten werkdruk: 45 bar.

### Membraanafsluiters met afdekkap

Art. Nr.	Type	Aansluiting		Kv Factor	Lengte	Prijs
		Flare	Soldeer			
00006750	6410/2	1/4"	-	0,40	68,0	37,99
00006966	6410/3	3/8"	-	1,00	74,0	39,08
00006967	6410/4	1/2"	-	1,45	78,0	41,30
00006968	6410/5	5/8"	-	1,70	78,0	43,50
00006969	6410/6	3/4"	-	3,50	98,0	78,61
00006756	6420/2	-	1/4"	0,40	57,0	37,99
00010611	6420/3	-	3/8"	1,00	61,0	39,08
00052445	6420/3S3	3/8" Male	3/8" Female	1,00	67,5	43,96
00006970	6420/4	-	1/2"	1,45	70,0	41,30
00006971	6420/5	-	5/8"	1,70	71,0	42,60
00006972	6420/6	-	3/4"	3,50	92,0	76,38
00006973	6420/7	-	7/8"	3,50	94,0	82,80

Let op: De prijzen in deze catalogus zijn een momentopname en kunnen wijzigen. De actuele prijzen vindt u steeds op onze webshop.

V-26/1/2026



6010/2



6012/22

- Toegelaten temperatuursbereik: -40 ~ +130°C.
- Maximum toegelaten werkdruk: 45 bar.

### Membranaafsluiters met afdekkap

Art. Nr.	Type	Aansluiting	Aansluiting	Aansluiting	Kv Factor	Prijs
		IN Flare	IN Soldeer	OUT Flare		
00012549	6010/2	1/4"	-	1/4"	0,27	20,08
00012359	6012/22	-	1/4"	1/4"	0,27	20,08

## HANDAFSLUITERS MEMBRAAN

### OP MONTAGEVOET BML



- Toegelaten temperatuursbereik: -55 ~ +100°C.
- Maximum toegelaten werkdruk: 28 bar.

### Membraan handafsluiters op montagevoet BML

Art. Nr.	Type	Code Danfoss	Aansluiting	Kv-Factor	Prijs
				m <sup>3</sup> /u	
00000738	BML 6	009G0101	1/4" SAE	0,30	67,20
00000741	BML 65	009G0202	1/4" ODS	0,30	81,80

## AFSLUITERS MET SOLDEERAANSLUITINGEN



6512/



6532/

- Toegelaten temperatuursbereik: -35 ~ +160°C.
- Maximum toegelaten werkdruk: 45 bar.

### Afsluiters met soldeeraansluitingen

Art. Nr.	Type	Aansluiting	Kv Factor	Prijs
		Soldeer		
00006782	6512/9	1 1/8"	8,40	158,27
00006786	6512/13	1 5/8"	25,00	404,94
00006788	6512/17	2 1/8"	40,00	721,14
00006787	6532/17	2 1/8"	48,50	723,25

F

F-23



## KRANEN VOOR VLOEISTOFTANK

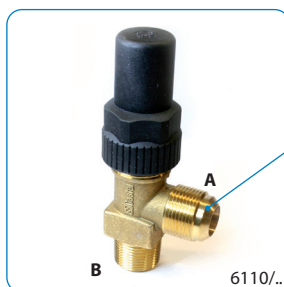

SAE

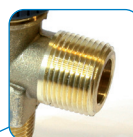
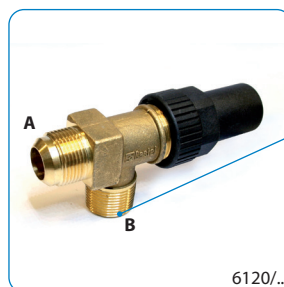

NPT

• Temperatuursbereik: -60 / +130°C.

### Kranen voor vloeistoftank

Art. Nr	Type	Aansluiting (A)	Aansluiting (B)	Kv Factor	PS	Prijs
				m <sup>3</sup> /u	bar	EUR
00007070	6110/22	1/4" SAE	1/4" NPT	0,44	45	20,20
00088782	6110E/X15	1/4" SAE	1/4" SAE	0,44	120	40,74
00007363	6110/23	1/4" SAE	3/8" NPT	0,45	45	21,31
00007364	6110/32	3/8" SAE	1/4" NPT	1,35	45	21,06
00007365	6110/33	3/8" SAE	3/8" NPT	1,35	45	21,51
00007366	6110/43	1/2" SAE	3/8" NPT	2,40	45	29,84
00007367	6110/44	1/2" SAE	1/2" NPT	3,40	45	30,77
00007368	6110/54	5/8" SAE	1/2" NPT	3,40	45	37,10
00007369	6110/66	3/4" SAE	3/4" NPT	6,00	45	70,28
00056515	6120/22	1/4" SAE	1/4" NPT	0,44	45	20,20
00056516	6120/23	1/4" SAE	3/8" NPT	0,45	45	21,06
00056517	6120/33	3/8" SAE	3/8" NPT	1,35	45	21,51
00056518	6120/43	1/2" SAE	3/8" NPT	2,40	45	29,84
00056519	6120/44	1/2" SAE	1/2" NPT	3,40	45	30,95
00056520	6120/54	5/8" SAE	1/2" NPT	3,40	45	37,10
00016242	6120/66	3/4" SAE	3/4" NPT	6,00	45	70,28

F

F-24



## CO<sub>2</sub> KRAAN

CASTEL



### Verzegelde kraan

Art. Nr.	Code	Soldeer aansluiting	Kv-factor	Temp. bereik	PS	Prijs
		Inch	m <sup>3</sup> /u	°C	bar	EUR
00082071	3064E/22	1/4"	2,50	-40 .. +150	80	138,18
00082072	3064E/33	3/8"	5,00	-40 .. +150	80	138,18
00082073	3064E/44	1/2"	10,00	-40 .. +150	80	138,18



### Overgangskoppeling

Art. Nr.	Code	NPT aansluiting	ODS aansluiting	PS	Prijs
		Inch		bar	EUR
00053390	3035/2	1/4"	12 mm	120	10,21
00064298	3035/3	3/8"	18 mm	120	12,32
00053391	3035/4	1/2"	22 mm	120	19,73
00092004	RACC012N1280	1/2"	1/2"	120	20,85

Let op: De prijzen in deze catalogus zijn een momentopname en kunnen wijzigen. De actuele prijzen vindt u steeds op onze webshop.

## SERVICE TOEBEHOREN



### Servicekraan druksonde Dixell

Art. Nr.	Code	Soldeer aansluiting	Flare aansluiting	Temp. bereik	PS	Prijs
		Inch	Inch	°C	bar	EUR
00081538	6012E/22	1/4" ODS	1/4" SAE	-35 .. +130	140	26,52



### Service kraan

Art. Nr.	Code	Omschrijving	Aansluiting	PS	Prijs
				bar	EUR
00089923	BV21A038G2K00	Service kraan (koper)	3/8" ODS - 3/8" G	120	129,20
00091904	BV21A010G2X00	Service kraan (Inox)	10 mm - 3/8" G	120	141,85
00064708	017-420566	Adapter druksonde Danfoss	1/4" SAE - 3/8" G	120	33,40



### Eurokoppeling - Verkocht per zak van 10 stuks

Art. Nr.	Code	Soldeer aansluiting	Flare aansluiting	PS	Prijs / zak
		Inch	Inch	bar	EUR
00082564	9901/X16	1/4" ODS	1/4" SAE	120	59,78
00082565	9901/X17	3/8" ODS	3/8" SAE	120	88,67
00082566	9901/X18	1/2" ODS	1/2" SAE	120	105,06



### Schraeder lasnippel

Art. Nr.	Code	Soldeer aansluiting	Flare aansluiting	PS	Prijs
		Inch	Inch	bar	EUR
00082593	8351/X02	1/4" - 3/8" IDS	1/4" SAE	120	1,51



### Schraeder

Art. Nr.	Code	Temp. bereik	Max. statische druk	PS	Prijs
		°C	bar	bar	EUR
00081268	8395/A4	-35 .. +120	140	80	4,68

Let op: De prijzen in deze catalogus zijn een momentopname en kunnen wijzigen. De actuele prijzen vindt u steeds op onze webshop.



## CO<sub>2</sub> TERUGSLAGKLEP

CASTEL



### Rechte terugslagklep - 80 bar

Art. Nr.	Type	ODS	Kv-waarde	PS	Prijs
		Inch	m <sup>3</sup> /u	bar	
00081523	3132EW/2	1/4"	0,50	80	54,80
00066533	3132E/3	3/8"	1,50	80	55,41
00066534	3132E/4	1/2"	1,80	80	56,41
00066535	3132E/5	5/8"	3,30	80	81,26
00066536	3132E/6	3/4"	5,00	80	88,44
00066537	3132E/7	7/8"	5,00	80	100,74

### Rechte terugslagklep - 120 bar

Art. Nr.	Type	ODS	Kv-waarde	PS	Prijs
		Inch	m <sup>3</sup> /u	bar	
00081529	3137E/2	1/4"	0,50	120	94,18
00081530	3137E/3	3/8"	1,50	120	94,18
00081531	3137E/4	1/2"	1,80	120	97,67
00081532	3137E/5	5/8"	3,30	120	116,85



## CO<sub>2</sub> TERUGSLAGKLEP

REFRIGERA



### Rechte terugslagklep - 60 bar

Art. Nr.	Type	ODS	Kv-waarde	PS	Prijs
		Inch	m <sup>3</sup> /u	bar	
00068142	CVR1038R0000	3/8"	1,40	60	62,09
00068143	REF3.1.R.0012.2.60	1/2"	2,95	60	60,98
00068144	REF3.1.R.016.2.60	5/8"	4,10	60	84,62
00068147	REF3.1.R.028.2.60	1.1/8"	12,75	60	172,72

F

F-26



## SMELTSTOPPEN



### Smeltstoppen

Art. Nr	Type	Max. werkdruk	Smeltpunt	Max. werk-temp.	Aansluiting	Prijs
		bar	°C	°C	NPT	
00010274	3080/2C	42	79	68	1/4"	31,47
00010275	3080/3C	42	79	68	3/8"	50,09
00010276	3080/4C	42	79	68	1/2"	73,22
00010278	3082/2C	30	138	127	1/4"	18,43
00010279	3082/3C	30	138	127	3/8"	20,96
00010280	3082/4C	30	138	127	1/2"	30,58

V-26/1/2026

## OVERDRUKKLEPPEN MET BREEKPLAAT



Pg. F-32

NEW!



- Maximum werkdruk: 55 bar.
- Temperatuursbereik: -50 / +150°C.

### Overdrukklep met breekplaat

Art. Nr.	Type	Ingang	Uitgang	Service	Orifice	Breek druk	Max. bedrijfsdruk	Prijs
		Inch	Inch				Inch	
00075367	3070/44C140	1/2" NPT	1/2" NPT	2 x 1/8" NPT	113	14	75% Pb	169,74
00075368	3070/44C160	1/2" NPT	1/2" NPT	2 x 1/8" NPT	113	16	75% Pb	169,74
00075369	3070/44C210	1/2" NPT	1/2" NPT	2 x 1/8" NPT	113	21	75% Pb	169,74
00075370	3070/44C240	1/2" NPT	1/2" NPT	2 x 1/8" NPT	113	24	75% Pb	169,74
00075371	3070/44C248	1/2" NPT	1/2" NPT	2 x 1/8" NPT	113	24,8	75% Pb	169,74
00075372	3070/44C275	1/2" NPT	1/2" NPT	2 x 1/8" NPT	113	27,5	75% Pb	169,74
00075373	3070/44C280	1/2" NPT	1/2" NPT	2 x 1/8" NPT	113	28	75% Pb	169,74

## OVERDRUKVENTIELEN



3030/..



3060/..

### 24 BAR

Art. Nr	Type	Aansluiting	Aansluiting	Aansluiting	Kv Factor	Lengte	Prijs
		IN NPT	OUT SAE	OUT G		m <sup>3</sup> /h	
00007069	3030/44C..	1/2" (M)	-	3/4" (M)	0,90	159	232,17
00007373	3030/66C..	3/4" (M)	-	3/4" (M)	0,90	159	232,17
00060515	3030/88C..	1" (M)	-	3/4" (M)	0,83	216	431,73
00007370	3060/23C..	1/4" (M)	3/8" (M)	-	0,63	80	61,89
00007371	3060/34C..	3/8" (M)	1/2" (M)	-	0,69	80	69,71
00007372	3060/45C..	1/2" (M)	5/8" (M)	-	0,45	89	68,90

### 28 BAR

Art. Nr	Type	Aansluiting	Aansluiting	Aansluiting	Kv Factor	Lengte	Prijs
		IN NPT	OUT SAE	OUT G		m <sup>3</sup> /h	
00016479	3030/44C..	1/2" (M)	-	3/4" (M)	0,90	159	232,17
00061279	3060/34C..	3/8" (M)	1/2" (M)	-	0,69	80	69,71
00016455	3060/45C..	1/2" (M)	5/8" (M)	-	0,45	89	68,90

F

F-27

Let op: De prijzen in deze catalogus zijn een momentopname en kunnen wijzigen. De actuele prijzen vindt u steeds op onze webshop.

V-26/1/2026

### 31 BAR

Art. Nr	Type	Aansluiting			Kv Factor	Lengte	Prijs
		IN NPT	OUT SAE	OUT G			
00025979	3060/34C..	3/8" (M)	1/2" (M)	-	0,69	82	69,71
00022102	3060/45C..	1/2" (M)	5/8" (M)	-	0,45	89	68,90

### 40 BAR

Art. Nr	Type	Aansluiting			Kv Factor	Lengte	Prijs
		IN NPT	OUT SAE	OUT G			
00051222	3060/45C..	1/2" (M)	5/8" (M)	-	0,45	89	73,38



Pg. F-34



Pg. F-36



Pg. G-30



3032/..

### Dubbele afsluitkraan voor overdrukventielen

Art. Nr	Type	Aansluiting		Overdrukventiel	Kv Factor	Prijs
		IN NPT	OUT NPT			
00014802	3032/44	1/2"(M)	2 x 1/2" (F)	3060/45C	3,30	202,56
00052737	3032/64	3/4" (M)	2 x 1/2" (F)	3030/44C	9,00	218,94
00015502	3032/66	3/4" (M)	2 x 3/4" (F)	3030/66C	9,00	218,91

## F



### CO<sub>2</sub> AFBLAASVENTIELEN MET VERZEGELING

CASTEL



- Bereik van 8 tot 50 bar.
- Maximum werkdruk van 55 bar.
- Alle types zijn beschikbaar op aanvraag, contacteer ons voor het type voor uw gewenste druk.

### Afblaasventielen met een verzegeling

Art. Nr.	Type	Ingang		Uitgang	kd-waarde	Temperatuur bereik	PS	Prijs
		Inch	Inch					
00054874	3030/44C	1/2" NPT	3/4" G	0,90	-40 .. +150	25	232,17	
00066621	3030/44C	1/2" NPT	3/4" G	0,90	-40 .. +150	45	236,53	
00066605	3030/66C	3/4" NPT	3/4" G	0,90	-40 .. +150	45	236,53	
00010607	3030/88C	1" NPT	1.1/4" G	0,83	-40 .. +150	28	431,73	
00066601	3030/88C	1" NPT	1.1/4" G	0,83	-40 .. +150	45	436,39	

## CO<sub>2</sub> AFBLAASVENTIELEN ZONDER VERZEGELING



CASTEL



- Bereik van 9 tot 50 bar.
- Maximum werkdruk van 55 bar.
- Alle types zijn beschikbaar op aanvraag, contacteer ons voor het type voor uw gewenste druk.

### Afblaasventielen zonder verzegeling

Art. Nr.	Type	Ingang	Uitgang	kd-waarde	Temperatuur bereik	PS	Prijs
		Inch	Inch		°C	bar	
00081734	3060/23C	1/4" PT	3/8" SAE	0,63	-40 .. +120	28	61,89
00061279	3060/34C	3/8" NPT	1/2" SAE	0,69	-40 .. +120	28	69,71
00078071	3060/36C	3/8" NPT	3/4" G	0,92	-40 .. +120	45	82,83
00016455	3060/45C	1/2" NPT	5/8" SAE	0,45	-40 .. +120	28	68,90
00074606	3060/45C	1/2" NPT	5/8" SAE	0,45	-40 .. +120	45	73,38
00072843	3060/46C	1/2" NPT	3/4" G	0,93	-40 .. +120	45	89,16



- Bereik van 11 tot 60 bar.
- Maximum werkdruk van 70 bar.
- Andere types zijn beschikbaar op aanvraag, contacteer ons voor het type voor uw gewenste druk.

### Afblaasventielen zonder verzegeling

Art. Nr.	Type	Ingang	Uitgang	kd-waarde	Temperatuur bereik	PS	Prijs
		Inch	Inch		°C	bar	
00082793	3061/2C	1/4" NPT	3/8" G	0,89	-50 .. +150	60	72,42
00081269	3061/4C	1/2" NPT	1/2" G	0,89	-50 .. +150	60	72,42

## CO<sub>2</sub> AFBLAASVENTIELEN

REFRIGERA



- Bereik van 0 tot 150 bar.
- Andere types zijn beschikbaar op aanvraag, contacteer ons voor het type voor uw gewenste druk.

### Overdrukventiel

Art. Nr.	Type	Ingang	Uitgang	kd-waarde	Temperatuur bereik	PS	Prijs
		Inch	Inch		°C	bar	
00082905	REF80.14.12	1/4" NPT	1/2" G			60	59,49
00068165	REF80.12.34	1/2" NPT	3/4" G			60	74,02
00081790	REF80.12.01	1/2" NPT	1" G			80	637,28
00068158	REF80.12.11	1/2" NPT	1.1/4" G			120	777,99



## CO<sub>2</sub> WISSELKRAAN

CASTEL



Wisselkraan voor twee overdrukventielen, voor een onderhoud of aanpassing terwijl de koelinstallatie in werking kan blijven.

### Wisselkraan voor twee overdrukventielen

Art. Nr.	Type	Ingang	Uitgang	Kv Factor	Temp. bereik	PS	Prijs
		Inch	Inch	m <sup>3</sup> /h	°C	bar	EUR
00014802	3032/44	1/2" NPT	1/2" NPT	3,3	-40 .. +120	80	202,56
00082960	3032E/44	1/2" NPT	1/2" NPT	3,3	-40 .. +120	120	283,09



## ROTALOCK



### Rotalock kranen

Art. Nr.	Type	Rot	Aansluiting	Prijs
			ODS	EUR
00042016	ROT0603	3/4"	3/8" (10ODS)	27,02
00011356	ROT0803	1"	3/8" (10ODS)	26,83
00013003	ROT0804	1"	1/2 (12ODS)	28,76
00013004	ROT0805	1"	5/8" (15ODS)	29,14
00015159	ROT1005	1 1/4"	5/8" (15ODS)	33,39
00015158	ROT1006	1 1/4"	3/4" (18ODS)	34,55
00033233	ROT1007	1 1/4"	7/8" (22ODS)	45,55
00033232	ROT1009	1 1/4"	1 1/8" (28ODS)	46,08
00041216	ROT1407	1 3/4"	7/8" (22ODS)	51,70
00015161	ROT1409	1 3/4"	1 1/8" (28ODS)	61,95
00041212	ROT1411	1 3/4"	1 3/8" (35ODS)	67,55
00027491	ROT1413	1 3/4"	1 5/8" (42ODS)	103,83
00041218	ROT1811	2 1/4"	1 3/8" (35ODS)	116,01
00041217	ROT1813	2 1/4"	1 5/8" (42ODS)	138,68
00041211	ROT1817	2 1/4"	2 1/8 (54ODS)	133,59

F

F-30

Let op: De prijzen in deze catalogus zijn een momentopname en kunnen wijzigen. De actuele prijzen vindt u steeds op onze webshop.

V-26/1/2026

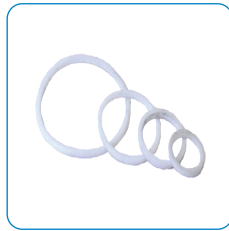
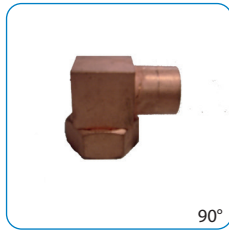

### Rotalock aansluitingen

Art. Nr.	Type	Rot	Hoek	Aansluiting	Prijs
				ODS	EUR
00031422	ROTADA0804	1"	90°	1/2"	19,11
00031429	ROTADA1007	1 1/4"	90°	7/8"	23,16
00031442	ROTADA1009	1 1/4"	90°	1 1/8"	28,18
00031446	ROTADA1413	1 3/4"	90°	1 5/8"	45,63
00031450	ROTADS0603	3/4"	180°	3/8"	11,77
00031448	ROTADS0606	3/4"	180°	3/4"	30,69
00031453	ROTADS0804	1"	180°	1/2"	16,02
00031456	ROTADS1006	1 1/4"	180°	3/4"	17,95
00031460	ROTADS1009	1 1/4"	180°	1 1/8"	18,91
00031464	ROTADS1413	1 3/4"	180°	1 5/8"	83,76

### Teflon dichting voor Rotalock

Art. Nr.	Rot	Type	Prijs
			EUR
00015168	R 3/4"	Teflon	5,25
00013005	R 1"	Teflon	1,44
00014839	R 1.1/4"	Teflon	2,16
00014840	R 1.3/4"	Teflon	2,51
00054108	R 2.1/4"	Teflon	5,25

### Adapter voor veiligheidsventiel

Art. Nr.	Type	Rot	Prijs
			EUR
00100811	1670026A	1 1/4" x 1/2" NPT	48,83
00027450	36600506	1 3/4" x 1/2" NPT	69,44

F

F-31



Pg. F-24



Pg. F-27



Pg. F-30



Pg. F-31



Pg. F-46



## VLOEISTOFVATEN

FRIGOMECC

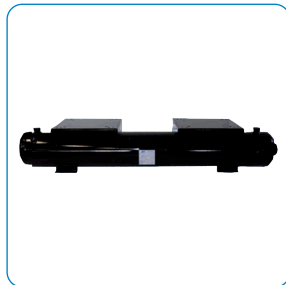

Uitgebreid gamma verticale of horizontale tanks met een verschillende inhoud.

- Voorzien van een stabiele grondplaat voor een stevige montage.
- Drie Rotalock kijkglazen om het vloeistofniveau te controleren.
- Afzonderlijke aansluitingen voorzien voor een laagniveau-alarm en veiligheidsventiel (1/2" NPT).
- Altijd voorzien van Rotalockconnecties op IN en UIT (Rotalock kranen niet meegeleverd).
- PED gekeurd.
- Grote voorraad en snel leverbaar.

### Verticale vaten

Art. Nr	Type	Volume	Diameter	Hoogte	Aansluiting IN	Aansluiting UIT	Prijs
		dm <sup>3</sup>	mm	mm	Inch	Inch	
00073588	FSR 25	25	219	765	1.3/4	1.1/4	718
00068230	FSR 125	125	324	174	1.3/4	1.3/4	1 974
00066192	FSR 150	150	356	1716	1.3/4	1.3/4	2 583

### Horizontale vaten

Art. Nr	Type	Volume	Diameter	Hoogte	Afmeting montageplaat	Aansluiting IN	Aansluiting UIT	Prijs
					mm	Inch	Inch	
00073521	FT15H	15	140	1100	540 x 360	1.1/4	1.1/4	653
00073520	FT20H	20	168	1020	540 x 360	1.1/4	1.1/4	672
00063308	FT30H	30	219	950	600 x 460	1.3/4	1.3/4	876
00072945	FT60H	60	273	1150	600 x 460	1.3/4	1.3/4	1 428

## OLIEAFSCHEIDERS



- Toegelaten temperatuursbereik: -10 ~ +130°C.
- Maximum toegelaten werkdruk 5540/4...5540/11: 45 bar.  
5540/13...5540/17: 32 bar.
- De aansluiting van de olieafscheider mag nooit kleiner zijn dan de diameter van de persleiding welke volgens de technische regels geselecteerd werd.
- $T_c = 40^\circ\text{C}$ .
- Olietoevoeging voor in bedrijfsname 5540/4...5540/11: 0,4-0,5 kg.  
5540/13...5540/17: 0,6-0,7 kg.



Pg. F-34



Pg. F-36

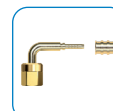

Pg. G-30

### Gesloten types - Niet demonteerbaar

Art. Nr	Type	ODS		R134a	R404A	R404A	R407C	R410A	Prijs
		mm	inch	-10°C	-30°C	-10°C	5°C	5°C	
00026307	5540/4	--	1/2"	5,7	7,2	8,5	9,7	12,0	256,23
00026309	5540/5	16	5/8"	11,7	14,5	17,1	19,4	23,9	268,65
00026310	5540/7	--	7/8"	14,4	18,1	21,3	24,3	29,9	280,43
00026311	5540/9	--	1 1/8"	17,2	21,7	25,6	29,1	35,9	321,68
00026313	5540/11	35	1 3/8"	20,1	25,3	29,9	34,0	41,9	350,74
00026312	5540/13	--	1 5/8"	32,7	37,6	48,6	55,3	-	589,11
00056514	5540/M42	42	--	32,7	37,6	48,6	55,3	-	589,11
00026314	5540/17	54	2 1/8"	40,9	51,5	60,8	69,1	-	626,08

## OLIEAFSCHEIDERS

### NIET DEMONTEERBAAR



OS-..



OS-..H

- Maximum werkdruk: 31 bar bij werkingstemp. 140/-10°C.
- Maximum werkdruk: 10 bar bij werkingstemp. -10/-40°C.
- Maximum temperatuur: 140°C
- De aansluiting van de olieafscheider mag nooit kleiner zijn dan de diameter van de persleiding welke volgens de technische regels geselecteerd werd.
- Het maximum theoretische slagvolume van de compressor mag de waarden (VHmax - m<sup>3</sup>/h) in de tabel niet overschrijden.

F

F-33

### Gesloten types - Niet demonteerbaar

Art. Nr	Type	ODS		Eerste olievulling	Vol	VHmax -10°C	VHmax -30°C	Prijs
		mm	inch	kg	dm <sup>3</sup>	m <sup>3</sup> /h	m <sup>3</sup> /h	
00010309	OS-10	10	3/8"	0,4	1,2	10	14	293,31
00056730	OS-10-12	12	--	0,4	2,3	12	20	303,69
00005393	OS-1/2"	--	1/2"	0,6	2,3	12	20	303,69
00005394	OS-16	16	5/8"	0,6	2,3	21	33	339,82
00005395	OS-18	18	--	0,6	3,5	32	50	379,88
00005396	OS-3/4"	--	3/4"	0,6	3,5	32	50	379,88
00005397	OS-22	22	7/8"	0,6	3,5	37	55	388,82
00005398	OS-28	28	1 1/8"	0,6	3,5	37	55	403,84
00005399	OS-35	35	1 3/8"	0,6	3,5	37	55	431,03
00005400	OS-42	42	1 5/8"	0,6	3,5	37	55	495,06
00005401	OS-22H	22	7/8"	1,2	7,5	60	100	478,24
00005402	OS-28H	28	1 1/8"	1,2	7,5	82	120	487,90
00005403	OS-35H	35	1 3/8"	1,2	7,5	92	130	510,08
00005404	OS-42H	42	1 5/8"	1,2	7,5	92	130	539,77
00005405	OS-54H	54	2 1/8"	1,2	7,5	92	130	633,49

Let op: De prijzen in deze catalogus zijn een momentopname en kunnen wijzigen. De actuele prijzen vindt u steeds op onze webshop.

V-26/1/2026



Pg. F-34



Pg. F-36



Pg. G-30

### Types met flens - Demonteerbaar vlottersysteem

Art. Nr	Type	ODS		Eerste olievulling	Vol	VHmax		Prijs
		mm	inch			-10°C	-30°C	
00005406	OS-22F	22	7/8"	0,6	3,7	40	61	508
00005407	OS-28F	28	1 1/8"	0,6	3,7	40	61	516
00005408	OS-35F	35	1 3/8"	0,6	3,7	40	61	569
00005409	OS-42F	42	1 5/8"	0,6	3,7	40	61	609
00041501	OS-42FL	42	1 5/8"	0,6	7,5	95	150	962
00049790	OS-42FH	42	1 5/8"	0,6	11,0	123	175	1 171
00005414	OS-54FH	54	2 1/8"	0,6	11,6	123	175	1 284
00049789	OS-42FY	42	1 5/8"	0,6	18,5	205	270	1 499
00049791	OS-54FY	54	2 1/8"	0,6	18,5	205	270	1 536
00005417	OS-67/64FH	64	2 1/2"	0,6	18,5	205	270	1 880
00005418	OS-67FH	67	2 5/8"	0,6	18,5	205	270	1 634
00023969	OS80/54FS	54	2 1/8"	0,6	21,0	345	450	3 121
00026132	OS80/67FS	67	2 5/8"	0,6	21,0	345	450	3 121
00027249	OS80FS	80	3 1/8"	0,6	21,0	345	450	3 121
00052850	OS80/54FX	54	2 1/8"	0,6	32,0	430	580	4 041
00048641	OS80/67FX	67	2 5/8"	0,6	32,0	430	580	4 041
00056731	OS80/FX	80	3 1/8"	0,6	32,0	430	580	4 041
00056732	OS80/89FX	89	3 1/2"	0,6	32,0	430	580	4 232
00065575	OS-104FY	104	4 1/8"	0,6	46,5	700	1000	5 400



### OLIERESERVOIRS EN TOEBEHOREN

F

F-34



- Aansluiting drukvereffening: 5/8"
- Maximum werkdruk: 31 bar (bij werkingstemperatuur 100/-10°C).  
10 bar (bij werkingstemperatuur -10/-40°C).

#### Oliereservoirs OSA

Art. Nr.	Type	Vol.	Aansl. IN	Aansl. OUT	Hoogte	Diam.	Prijs
		dm <sup>3</sup>	mm	inch			
00005434	OSA - 7,5	7,5	3/8"	1/2"	345	200	455
00005435	OSA - 11	10,5	3/8"	5/8"	441	200	545
00005436	OSA - 18	18,0	3/8"	5/8"	375	300	989
00049089	OSA - 32	32,0	7/8"	7/8"	790	273	1 779

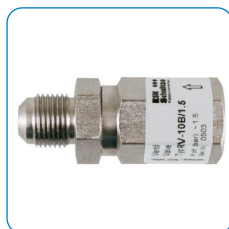

#### Terugslagkleppen RV

Art. Nr.	Type	Diff. druk	Aansl. IN	Aansl. OUT	Prijs
		dm <sup>3</sup>	SAE F	SAE M	
00004553	RV -10B/0,1	0,1	3/8"	3/8"	82,99
00056734	RV -10B/0,5	0,5	3/8"	3/8"	86,92
00005432	RV -10B/1,5	1,5	3/8"	3/8"	75,47
00056735	RV -10B/2,5	2,5	3/8"	3/8"	86,92

Let op: De prijzen in deze catalogus zijn een momentopname en kunnen wijzigen. De actuele prijzen vindt u steeds op onze webshop.

V-26/1/2026



• Temperatuursbereik: -40/+80°C.



Pg. F-34



Pg. F-36

### Oliefilters

Art. Nr.	Type	Filter opp.	Aansluiting	Diameter	Lengte	Kv factor	Max. druk	Prijs
		cm <sup>3</sup>	Inch	mm	mm	m <sup>3</sup> /u	bar	EUR
00073523	4510/3	58,0	3/8" SAE	52	110	2,4	45	39,59
00075374	4520/3	58,0	3/8" ODS	52	109	2,4	45	29,81
00075375	4520/4	58,0	1/2" ODS	52	122	3,4	45	30,58



Pg. G-30



Flare



Soldeer

• PS1: maximum werkdruk bij werkingstemperatuur 70/-10°C.  
• PS2: maximum werkdruk bij werkingstemperatuur -10/-40°C.

### Oliefilters Flare

Art. Nr.	Type	Vol.	Aansl. IN	Diam	Lengte	PS1	PS2	Prijs
		dm <sup>3</sup>	SAE	mm	mm	bar	bar	EUR
00004546	F- 6B	0,1	1/4"	77	74	53	39	93,72
00005383	F- 10B	0,1	3/8"	77	82	53	39	88,35
00005384	F- 12B	0,1	1/2"	77	88	53	39	93,72
00005385	F- 16B	0,1	5/8"	77	94	53	39	98,37
00005386	F- 18B	0,1	3/4"	77	104	53	39	98,37

### Oliefilters Soldeer

Art. Nr.	Type	Vol.	Aansl. IN	Diam	Lengte	PS1	PS2	Prijs
		dm <sup>3</sup>	SAE	mm	mm	bar	bar	EUR
00005387	F- 10L	0,1	3/8"	77	70	53	39	88,35
00005388	F- 12L	0,1	1/2"	77	76	53	39	93,72
00005389	F- 16L	0,1	5/8"	77	88	53	39	98,37
00005390	F- 18L	0,1	3/4"	77	94	53	39	126,27
00005391	F- 22L	0,1	7/8"	77	106	53	39	128,41
00047954	F- 28L	0,2	1-1/8"	108	119	31	23	237,87
00048335	F- 35L	0,2	1-3/8"	108	131	31	23	237,87

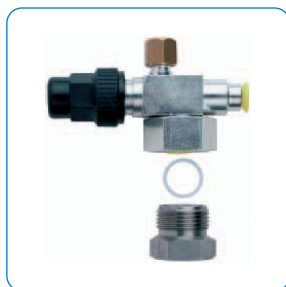

• Maximum toegelaten werkingsdruk: 45 bar.  
• Maximum werkingstemperatuur: 100°C.

### Aansluitkranen

Art. Nr.	Type	Aansluitingen	Prijs
			EUR
00016480	AS VALVE SET	3/8" - 1/2" - 5/8"	88,35

F

F-35



## OLIERESERVOIRS EN TOEBEHOREN

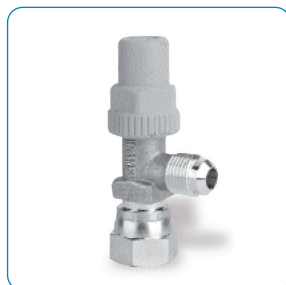

- Toegelaten temperatuursbereik: -60 ~ +130°C.
- Maximum toegelaten werkdruk: 45 bar.

### Aansluitkranen

Art. Nr.	Type	Aansluitingen	Kv factor	Prijs
		Inch	m <sup>3</sup> /u	
00060218	6110/X13	3/8" M - 3/8" F	1,35	29,44



## OLIE NIVEAUREGELAARS

### MECHANISCH



OR-0-BC



ORE2-0-BC

- PS1: maximum werkdruk bij werkingstemperatuur 100/-10°C.
- PS2: maximum werkdruk bij werkingstemperatuur -10/-40°C.

### Mechanische olieniveauregelaars

Art. Nr.	Type	Versie	Aansluiting	Δp max.	kijk-glazen	Vol.	P1	P2	Prijs
		Niveau		Bar					
00053560	OR-0-BC	Niet instelbaar	3/4 bout	4,2	2	0,5	40	10	290,45
00056736	ORL-OC	Niet instelbaar	Draad	4,2	1	0,5	40	10	320,14
00053533	ORE2-0-BC	Instelbaar	3/4 bout	6,5	2	0,5	40	10	351,98
00056738	OREL-OC	Instelbaar	Draad	6,5	1	0,5	40	10	365,93

### Afmetingen

Art. Nr.	Figuur	A	D	B	H	K	DS
		mm	mm	mm	mm	mm	mm
OR-0-BC	a	81	108	142	81	51	60
ORL-OC, ORL-SN	c *5	107	108	125	81	51	-
ORE2-0-BC	b	100	108	142	104	51	60
OREL-OC, OREL-SN	c *5	107	108	125	104	51	-
ORE2-0-BC-1	d	100	108	125	104	51	60

Let op: De prijzen in deze catalogus zijn een momentopname en kunnen wijzigen. De actuele prijzen vindt u steeds op onze webshop.

1. Kijkglas met niveau indicator
2. Stelmoer
3. Aansluiting voor olie toevoer, 3/8" flare

4. Flens
- \*5. Zonder stelmoer
6. Adapter type OC of SN

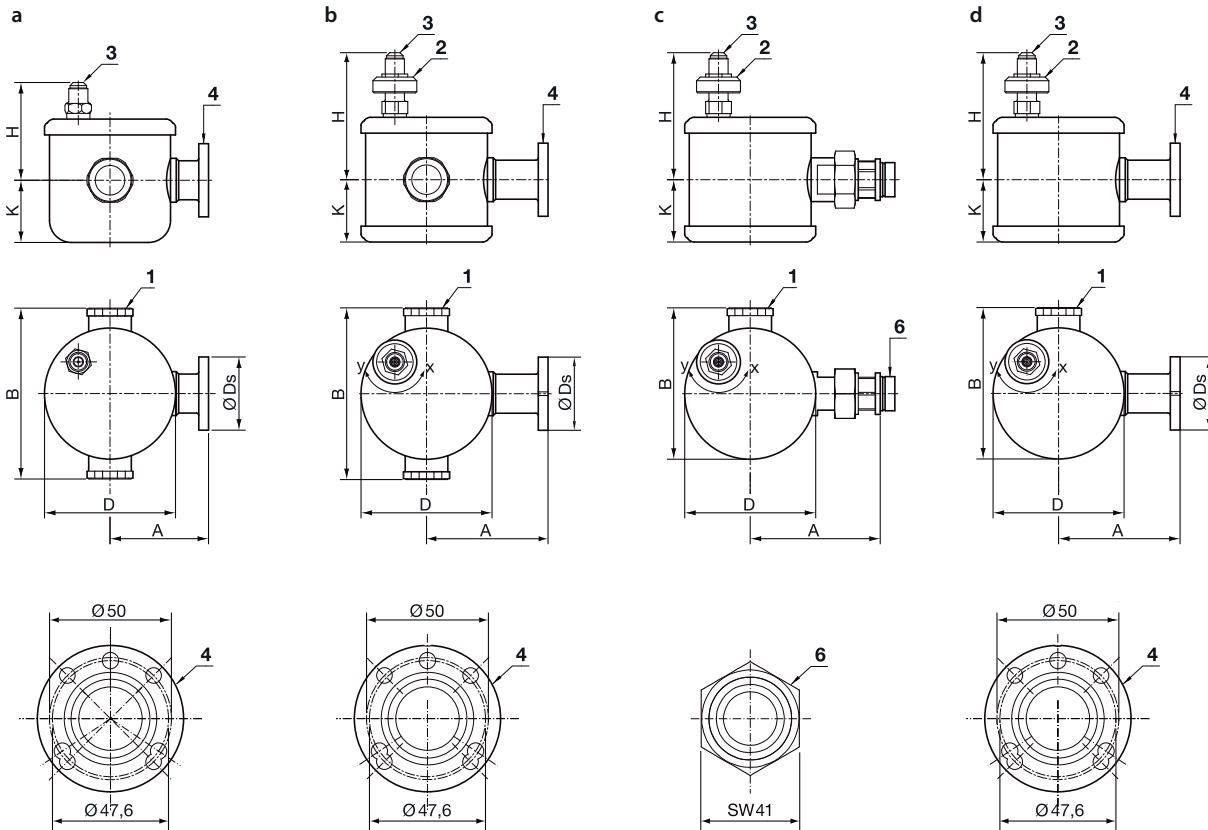

A-3-4FL-SG-28L



A-1-1/8"-SG-28L

- PS1: maximum werkdruk bij werkingstemperatuur 70/-10°C.
- PS2: maximum werkdruk bij werkingstemperatuur -10/-40°C.

### Speciale adapters

Art. Nr.	Type	Aansluiting	P1	P2	Prijs
		Inch	Bar	Bar	EUR
00065579	A-3-4FL-SG-28L	1 1/8"	60	45	204,60
00065580	A-1-1/8"-SG-28L	1 1/8"	60	45	249,32
00065581	A-3/4"NTP-SG-28L	1 1/8"	60	45	249,32



### Wisselstukken

Art. Nr.	Type	Voor type	Service-aansluiting	Prijs
				EUR
00004548	SVF-10B	OS-22F ... OS-104FY, OS-54FS-CDA	Nee	382,74
00065582	SVF-10B-1"	OS-22F ... OS-104FY	Ja	441,40

F

F-37

Let op: De prijzen in deze catalogus zijn een momentopname en kunnen wijzigen. De actuele prijzen vindt u steeds op onze webshop.

## Adapters voor olieniveauregelaars



Pg. F-34



Pg. F-36



Pg. G-30

Art. Nr.	Type	Prijs
		EUR
00004554	A	134,85
00005446	BO	157,75
00005440	MA	137,00
00005438	R	137,00
00056742	MR	163,11
00062063	ME	114,46

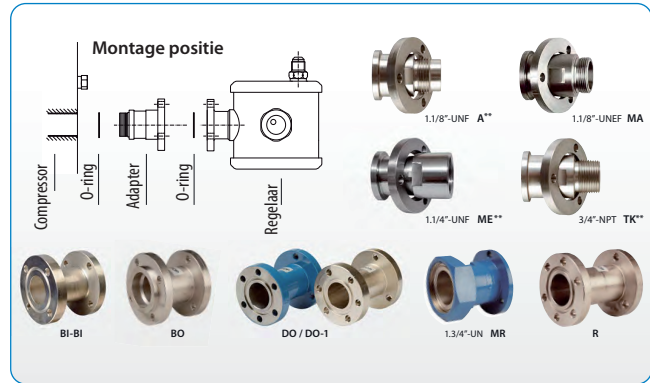

Type	Versie	Rechtstreekse montage, ZONDER adapter		Adapter voor installatie noodzakelijk		
		Fabrikant	Serie	Fabrikant	Serie	Adapter
OR-0-BC ORE2-0-BC ORE2-0-BC-1 ERM4-0-BC ERM4-0-BC-B	3/4" flens	<b>BITZER:</b>	4Z..4G, S4.; 4JE., 6J.,6F.,* S6, 4VC., 4NC., 4VE..4FE, 4SL...4NSL, 6J..6FE*	<b>BITZER:</b>	2KC...2CC, 2KE..4CE, 2MSL...4CSL, 4FC...4CC, 4MTC...4FTC 8FC., 8GC., 8G...8FE	<b>MA</b> <b>MA</b> <b>R</b>
		<b>BOCK:</b>	HA***., HG***.,	<b>BOCK:</b>	F., AM., HA/HG 12..34P	<b>BO</b> <b>MA</b>
				<b>CARRIER:</b>	DA., DR., 5F., 5H.,	<b>CR</b>
ERHD4-0-BC ERHD4-0-BC-B	3/4" bout	<b>COPELAND:</b>	DM., D2., D3., D4., D6.H., D6.S., D9., 4M., 6M...	<b>COPELAND:</b>	DK., DL., D6D., D..6J/T, D8., ZB15K., 92K; ZS15K.,92K; ZF09K.,48K ZR90K.,ZR19M ZR94K.,190K; ZB50K..114K; ZP90K.,182K	<b>A**</b> <b>R</b> <b>TK**</b> <b>MR</b> <b>ME**</b>
		<b>DORIN:</b>	K2., K3., K4., K5., K6., H4..H7, H34...H5, SCC_32..SCC_4 CDS 35, CDS41	<b>DORIN:</b>	CDS11, K1., SCC_1, H32 K7., CD300, CD400 CD200	<b>MA</b> <b>R</b> <b>DO</b> <b>DO-1</b>
		<b>FRASCOLD:</b>	A., B., D., F., S., V.,	<b>FRASCOLD:</b>	Z., W.,	<b>R</b>
ORL-OC OREL-OC	Draad	<b>BITZER:</b>	2EC..2CC.; 2GC., 4FC..4CC., 2KE..4CE, 2MSL...4CSL, 4MTC...4FTC	<b>GOELDNER:</b>	HS/HT/HZ/O 44 Adapter: ID.Nr. ES.200.9	
		<b>BOCK:</b>	HA/HG 12..34P			
		<b>DANFOSS:</b>	MT..V, LTZ...V,			
		<b>DORIN:</b>	CDS11, K1., SCC_1, H32			
		<b>GOELDNER:</b>	HS/HT/HZ/O 12..34			
ERM4-OC ERM4-OC-B ERHD4-OC ERHD4-OC-B	Draad	<b>BITZER:</b>	2KC...2CC., 4FC..4CC., 2KE..4CE, 2MSL...4CSL, 4MTC...4FTC			
		<b>BOCK:</b>	HA/HG12..34P			
		<b>DANFOSS:</b>	MT ..V, LTZ...V,			
		<b>DORIN:</b>	CDS11, K1., SCC_1, H32			
ORL-SN, OREL-SN ERM4-SN, ERHD4-SN	Draad	<b>COPELAND:</b>	ZB15K., 92K**; ZS15K.,92K**; ZF09K.,48K**			

\* ERM / ERHD4: verlengadapter "BI-BI" vereist.  
 \*\* Geen alarmfunctie voor de ERM/ERHD beschikbaar.  
 \*\*\* Montage van de regelaar met de Bock-schroeven.  
 Andere adapters op aanvraag.

V-26/1/2026

F

F-38

## OLIENIVEAUREGELAARS

### ELEKTRONISCH



- OM4-Series voor CO<sub>2</sub> en R410A.
- OM3-Series voor HFC's.
- IP65 door gegoten behuizing en nieuwe elektrische connecties met gegoten aansluitingen
- 3 zones, controle door het gebruik van geavanceerde sensoren voor een precieze meting
- CE-gekeurd onder lage stroom en EMC-richtlijn
- SPDT-uitgang om de compressor te stoppen of voor alarmering (230Vac/3A)
- Eenvoudige installatie met vervangkijkglas en montage vooraan
- Onafhankelijk onderdeel met olieniveausensor en magneetventiel om het olieniveau te regelen
- Alarm, status en 3 zone indicatie door LED's
- Voeding 24Vac, 50/60Hz
- Adapters geschikt voor diverse types compressor

#### Kijkglas niveau-controle zones

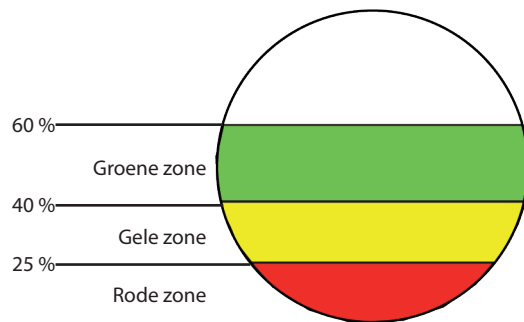

#### LED indicator

LED	Status / Functie
● Groen	Olieniveau in groene zone (60-40%)
● Groen    ● Geel	Olieniveau in groene zone (60-40%) & injectie
● Geel	Olieniveau in gele zone (40-25%) & injectie
● Rood    ● Geel	Olieniveau in rode zone (25-0%) & injectie

#### Selectie

Met flensadapter 3- / 4-gaten		Met schroefadapter 3/4" - 14 NPTF	
<b>OM3-CUA</b> 805 030	Arctic Circle	G2, G4, G6	Bitzer ZL, ZM
	Bitzer	4VC, 4TC, 4PC, 4NC, 4J, 6H, 6G, 6F, 8GC, 8FC	Copeland ZB (uitz. ZB50, 58, 66, 76, 95, 114, 220), ZF, ZS
	Bock	HA, HG (uitz. HG/HA-34/22, zie -CBB), O-series	<b>OM3-CCB</b> 805 034
	Copeland	D2, D3, D4, D6, D9, 4CC, 6CC	<b>Met schroefadapter 1 1/8" - 12 UNF</b> Copeland DK, DL
	Dorin	Alle KP, K-maten (uitz. deze vermeld bij -CBB)	<b>OM3-CCC</b> 805 035
Frascold	Series A, B, D, F, S, V, W, Z	<b>Met flensadapter 3-gaten</b> Copeland D8D, D8S_ (uitz. D8SJ en D8SK, enkel installatie op één kijkglas)	
<b>OM3-CBB</b> 805 032	<b>Met schroefadapter 1 1/8" - 18 UNEF</b>		<b>OM3-CCD</b> 805 031
	Bitzer	2KC, 2JC, 2HC, 2GC, 2FC, 2EC, 2DC, 2CC, 4FC, 4EC, 4DC, 4CC	<b>Met Rotalock adapter 1 3/4" - 12 UNF</b> Copeland ZB220, ZR90 .. ZR19M, ZR250, .. ZR380, ZRT180K tot 760K, ZRU280K-560K, ZRY480K-1140K
	Bock	HA12/22/34, HG12/22/34	<b>OM3-CCE</b> 805 029
	Dorin	Alle H, K100CC/CS, K150CC/CS, K180CC/CS, K200CC, K230CS, K235CC, K240SB, K40CC, K50CS, K75CC/CS-	<b>Met Rotalock adapter 1 1/4" - 12 UNF</b> Copeland ZB50, 58, 66, 76, 95, 114, ZR108/125/144, ZR94/160/190
	L'Unité Hermétique	TAH, TAG	
Maneurop	LT, MT, SM, SZ		

Andere types op aanvraag

#### Toebehoren kabels voor OM3

Type	PCN	Verbinding met...	Temperatuursbereik	Lengte kabel	Gewicht
OM3-P30	805 151	Stroomtoevoer en magneetventiel	-25 / +80 °C	3 m	0,24 kg
OM3-P60	805 152			6 m	0,25 kg
OM3-N30	805 141	Relais		3 m	0,13 kg
OM3-N60	805142			6 m	0,14 kg

Let op: De prijzen in deze catalogus zijn een momentopname en kunnen wijzigen. De actuele prijzen vindt u steeds op onze webshop.



Pg. F-34

#### Relaisconnector OM3-Nxx

A = blauw (open bij alarm)  
 B = zwart (gemeenschappelijk)  
 C = bruin (gesloten bij alarm)  
 (Verbind de compressor niet rechtstreeks met de OM3, maar via een aparte vermogensrelais.)

Stroomtoevoer OM3-Pxx = 24Vac  
 (OM-230V-3 transfo)

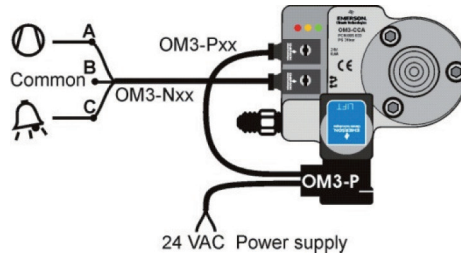

#### Opmerking:

Het is aangeraden om de OM3 permanent onder spanning te houden, ook tijdens standby en uitval.



Pg. F-36



Pg. G-30

#### Afmetingen

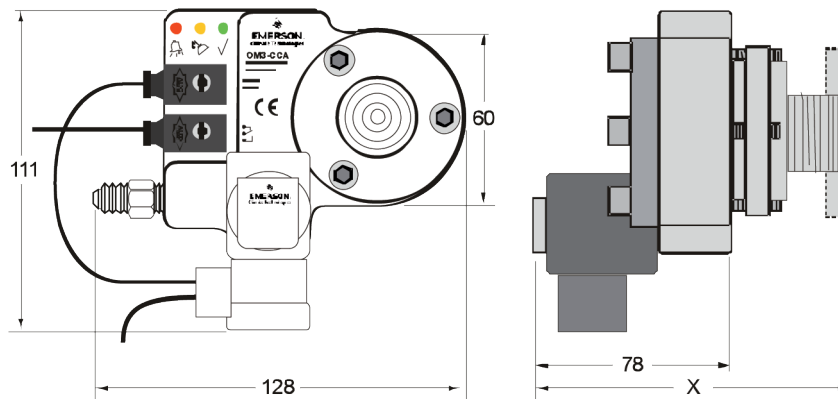

#### Opmerking:

De basisunit moet horizontaal gemonteerd worden voor correcte werking, maximaal 1° afwijking!

#### Bijhorende kabels

Art. Nr	Type	Referentie	Verbinding met...	Prijs
				<b>EUR</b>
00064746	OM3-P30	805 151	Stroom en magneetventiel	41,58
00065179	OM3-P60	805 152	Stroom en magneetventiel	50,27
00064747	OM3-N30	805 141	Relais	22,21
00065180	OM3-N60	805 142	Relais	31,73

F

F-40

V-26/1/2026



Pg. F-34



Pg. F-36



Pg. G-30

Adapters	Zijaanzicht	Vooraanzicht (richting compressor)
<p><b>OM0-CBB (805 038)</b> schroefadapter 1 1/8" - 18 UNF Zoals gebruikt bij CBB Bijkomende flensring voor adapter / verbinding basis-unit (inbegrepen)</p>		
<p><b>OM0-CCA (805 039)</b> schroefadapter 3/4" - 14 NPTF Zoals gebruikt bij CCA Bijkomende flensring voor adapter / verbinding basis-unit (inbegrepen)</p>		
<p><b>OM0-CCB (805 040)</b> schroefadapter 1 1/8" - 12 UNF Zoals gebruikt bij CCB Bijkomende flensring voor adapter / verbinding basis-unit (inbegrepen)</p>		
<p><b>OM0-CCC (805 041)</b> 3-gaten flensadapter</p>		
<p><b>OM0-CCD (805 042)</b> Rotalock adapter 1 3/4" - 12 UNF Adapter als één geheel, bestaande uit OM0-CCA en Rotalock adapter 1 3/4" - 12 UNF</p>		

**Adapters**

Art. Nr	Type	Referentie	Type adapter	Prijs
				<b>EUR</b>
00064744	OM0-CBB	805 038	Schroefadapter 1 1/8" - 18 UNF	117,74
00065181	OM0-CCA	805 039	Schroefadapter 3/4" - 14 NPTF	117,74
00065182	OM0-CCB	805 040	Schroefadapter 1 1/8" - 12 UNF	117,74
00065183	OM0-CCC	805 041	Flensadapter 3-gaten	117,74
00065184	OM0-CCD	805 042	Rotalock adapter 1 3/4" - 12 UNF	133,10



**ESK** ❄️❄️❄️  
**Schultze**  
Kältekomponenten

**VLOEISTOFAFSCHEIDER FA**

**SELECTIETABEL**

Voorbeeld: selectie voor ééntrapscompressoren.

- Bepaal Vo als volgt:  $V_o = V_H(\text{theoretisch slagvolume compressor}) \times \lambda$  (vol. rendement).
- $\lambda$  volgt uit nevenstaande grafiek, waarbij eerst de drukverhouding  $P/P_o$  dient bepaald.
- $P$  = absolute condensordruk,  $P_o$  = absolute verdampersdruk.
- Een goede selectie veronderstelt dat  $V_o$  tussen  $V_o\text{-opt.}$  en  $V_o\text{-min.}$  ligt !
- Opgelet bij capaciteitsregeling:  $V_o$  hoger dan  $V_o\text{-min.}$

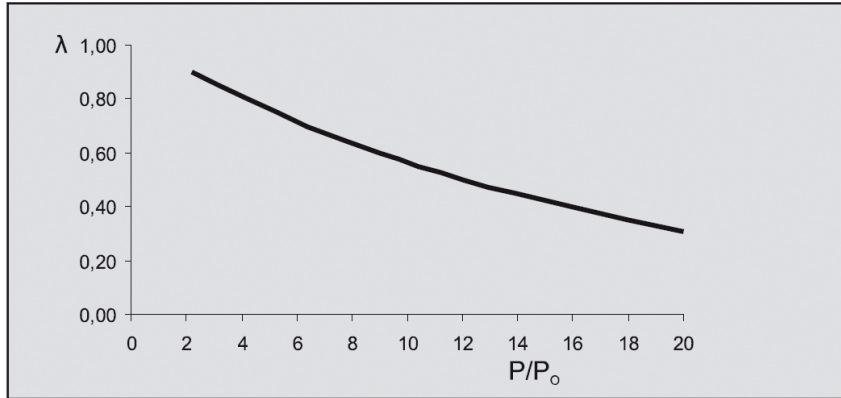

Pg. F-36



Pg. G-30

**F**

F-42

Suction Line-Accumulator Connection Size			Ref. Capacity Q <sub>0</sub> [kW] at 40 °C Condensing Temperature and 25°C Suctiongas Temperature Evaporating Temperature [°C], single stage operation																	Effective Displacement		
ØSL mm	ØSL inch	Typ / Type	R404A, R407A, R407C, R507, R22											R410A				R134a				V <sub>o</sub> m³/h
			+5	0	-5	-10	-15	-20	-25	-30	-35	-40	+5	-5	-15	-25	+5	-10	-20	-30		
12	-	FA-12/15	Opt. 4,3	3,8	3,2	2,6	2,1	1,7	1,4	1,2	1,0	0,7	6,0	4,4	3,0	2,0	2,8	1,6	1,0	0,6	4,0	
			Min. 2,2	1,9	1,6	1,3	1,1	0,9	0,7	0,6	0,5	0,4	3,0	2,2	1,5	1,0	1,4	0,8	0,5	0,3	2,0	
15	-	FA-12/15	Opt. 7,1	6,2	5,4	4,6	3,5	2,9	2,4	1,9	1,6	1,2	10,4	7,4	5,2	3,6	4,7	2,6	1,8	1,1	6,6	
			Min. 3,6	3,1	2,7	2,3	1,8	1,5	1,2	1,0	0,8	0,6	5,2	3,7	2,6	1,8	2,4	1,3	0,9	0,5	3,3	
16	5/8	FA-16...	Opt. 8,4	7,6	6,4	5,2	4,1	3,3	2,8	2,3	2,0	1,4	12,0	8,6	6,0	4,0	5,5	3,0	2,0	1,2	7,8	
			Min. 4,2	3,8	3,2	2,6	2,1	1,7	1,4	1,2	1,0	0,7	6,0	4,3	3,0	2,0	2,8	1,5	1,0	0,6	3,9	
22	7/8	FA-22...	Opt. 17,0	15,0	12,6	10,6	8,3	7,0	5,5	4,6	3,8	2,9	25,0	18,0	12,0	8,4	10,2	5,6	3,6	2,4	15,8	
			Min. 8,5	7,5	6,3	5,3	4,2	3,6	3,0	2,3	1,9	1,5	12,5	9,0	6,0	4,2	5,1	2,8	1,8	1,2	7,9	
28	1-1/8	FA-28...	Opt. 26,7	23,0	19,0	16,0	13,0	11,0	8,8	7,2	5,8	4,5	38,4	28,0	20,0	13,0	17,5	9,8	6,4	4,0	24,8	
			Min. 13,4	11,5	9,5	8,0	6,5	5,5	4,5	3,6	2,9	2,3	19,2	14,0	10,0	6,5	8,7	4,9	3,2	2,0	12,4	
35	1-3/8	FA-35...	Opt. 44	36	32	26	22	18	14,0	12	10	8	64	46	32	22	26,8	15,0	9,8	6,2	40,6	
			Min. 22	18	16	13	11	9	7,0	6	5	4	32	23	16	11	13,4	7,5	4,9	3,1	20,3	
42	1-5/8	FA-42...	Opt. 62	52	46	36	30	25	20	16	14	10	94	66	46	32	40	22	14	9,0	57,2	
			Min. 31	26	23	18	15	13	10	8	7	5	47	33	23	16	20	11	7	4,5	28,6	
54	2-1/8	FA-54...	Opt. 107	92	76	64	52	43	35	28	24	18	154	110	76	52	70	40	26	16	99,0	
			Min. 53	46	38	32	26	22	18	14	12	9	77	55	38	26	35	20	13	8	49,5	
64	2-1/2	FA-67/64...	Opt. 153	128	108	90	75	62	50	42	34	26	220	158	110	76	100	56	36	24	142	
			Min. 77	64	54	45	38	31	25	21	17	13	110	79	55	38	50	28	18	12	71	
67	2-5/8	FA-67...	Opt. 168	142	122	100	84	72	58	48	38	30	244	174	122	84	108	62	40	26	148	
			Min. 84	71	61	50	42	36	29	24	19	15	122	87	61	42	54	31	20	13	74	
70	2-3/4	FA-67/70...	Opt. 180	154	132	108	90	76	62	50	40	32	268	192	134	92	114	66	44	28	163,0	
			Min. 90	77	66	54	45	38	31	25	20	16	134	96	67	46	57	33	22	14	81,5	
80	3-1/8	FA-80...	Opt. 240	208	176	146	124	104	84	70	56	44	356	254	178	122	158	89	58	36	218	
			Min. 120	104	89	73	62	52	42	35	28	22	178	127	89	61	79	45	29	18	109	
89	3-1/2	FA-80/89...	Opt. 310	266	226	188	158	132	108	88	72	56	444	318	222	152	202	114	74	48	270	
			Min. 155	133	113	94	79	66	54	44	36	28	222	159	111	76	101	57	37	24	136	
104	4-1/8	FA-104...	Opt. 430	360	304	256	210	172	140	116	92	73	600	430	300	200	270	152	98	62	400	
			Min. 215	180	152	128	105	86	70	58	46	37	300	215	150	100	135	76	49	31	200	

Ø SL = Saugleitungs-Außendurchmesser  
Suction Line Outside Diameter

Einsatz nur mit Wärmetauscher oder Heizelementen  
Application with heat exchanger or heater elements only

Let op: De prijzen in deze catalogus zijn een momentopname en kunnen wijzigen. De actuele prijzen vindt u steeds op onze webshop.

## VLOEISTOFAFSCHEIDERS

**ESK** ❄️❄️❄️  
**Schultze**  
Kältekomponenten



Pg. F-34



Pg. F-36

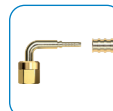

Pg. G-30



FA12/15



FA16-1,5



FA67-18



FA35W



FA 104-32W

### Vloeistofafscheiders

Art. Nr.	Type	ODS		Vol	Prijs
		mm	inch		
00004549	FA 12/15	12	1/2"	0,3	123
00005449	FA 16-1,5	16	5/8"	1,5	135
00005450	FA 16-2	16	5/8"	2	141
00005451	FA 16	16	5/8"	2,3	141
00005452	FA 22-2	22	7/8"	2	187
00005453	FA 22	22	7/8"	3,5	195
00024130	FA 22-7	22	7/8"	7,1	251
00005455	FA 28-2	28	1 1/8"	2	206
00005456	FA 28	28	1 1/8"	3,5	212
00005457	FA 28-7	28	1 1/8"	7,5	239
00005458	FA 35	35	1 3/8"	7,5	281
00005459	FA 42	42	1 5/8"	7,5	370
00005460	FA 54-7	54	2 1/8"	7,5	528
00005461	FA 54-9	54	2 1/8"	9,5	693
00048798	FA 67-18	67	2 5/8"	18	1 321
00005462	FA 80	80	3 1/8"	18	1 662
00005463	FA 80/89	89	3 1/2"	18	1 887
00056744	FA 54-32	54	2 1/8"	32	3 096
00056745	FA 67-32	67	2 5/8"	32	3 096
00056746	FA 80-32	80	3 1/8"	32	3 103
00056747	FA 89-32	89	3 1/2"	32	3 358
00051589	FA 104-32	104	4 1/8"	32	3 424

### Vloeistofafscheiders met warmtewisselaar

Art. Nr.	Type	ODS		Vol	Prijs
		mm	inch		
00004550	FA 16W	16	5/8"	2,3	251
00005469	FA 22W	22	7/8"	3,5	286
00005470	FA 28W	28	1 1/8"	3,5	342
00005471	FA 35W	35	1 3/8"	7,5	433
00005472	FA 42W	42	1 5/8"	7,5	509
00016508	FA 54-7W	54	2 1/8"	7,5	662
00056748	FA 67-18W	67	2 5/8"	18	1 424
00056749	FA 80W	80	3 1/8"	18	1 780
00056751	FA 54-32W	54	2 1/8"	32	3 484
00056752	FA 67-32W	67	2 5/8"	32	3 485
00056753	FA 80-32W	80	3 1/8"	32	3 616
00056754	FA 89-32W	89	3 1/2"	32	3 687
00054456	FA 104-32W	104	4 1/8"	32	3 679

F

F-43

Let op: De prijzen in deze catalogus zijn een momentopname en kunnen wijzigen. De actuele prijzen vindt u steeds op onze webshop.



Pg. F-34



Pg. F-36



Pg. G-30



### Vloeistofafscidders met dubbel vat

Art. Nr	Type	ODS		Vol.	Prijs
		mm	inch		
00005465	FA 54T	54	2 1/8"	2 x 7,5	907
00005466	FA 67/64T	64	2 1/2"	2 x 7,5	1 099
00005468	FA 67T	67	2 5/8"	2 x 7,5	1 320
00005467	FA 67/70T	70	2 3/4"	2 x 7,5	1 392



### Vloeistofafscidders met dubbel vat en warmtewisselaar

Art. Nr	Type	ODS		Vol.	Prijs
		mm	inch		
00027094	FA 54WT	54	2 1/8"	2 x 7,5	1 153
00056756	FA 67/64WT	64	2 1/2"	2 x 7,5	1 519
00056757	FA 67WT	67	2 5/8"	2 x 7,5	1 424

## VLOEISTOFAFSCHEIDERS

FRIGOMECC



### Vloeistofafscidders

Art. Nr	Type	ODS	Volume		Prijs
			dm <sup>3</sup>	EUR	
00057850	02/S-1/2	1/2"	1,3	86	
00057851	03/S-5/8	5/8"	1,6	99	
00060183	05/S-22	22 mm	3,4	143	
00027324	06/S-28	28 mm	4,6	182	
00027279	08/S-35	35 mm	7,8	270	
00064267	09/S-35	35 mm	11	281	
00027763	09/S-42	42 mm	11	318	
00028503	10/S-54	54 mm	19	468	
00072297	12/S-SP67	67 mm	30	1 114	
00068466	13/S-SP80	80 mm	35	1 287	

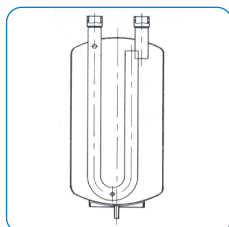

F

F-44



### Verwarmingselementen

Art. Nr	Type	Spanning	Vermogen	Diameter	Prijs
		V	Watt	mm	
00026531	HB 45/125	1x230 (50Hz)	45	100...160	192,80
00023984	HB 55/195	1x230 (50Hz)	55	190...250	202,10
00027197	HB 65/300	1x230 (50Hz)	65	270...300	211,76

## MUFFLERS

**ESK** ❄️❄️❄️  
**Schultze**  
Kältekomponenten



Pg. F-34



Pg. F-36

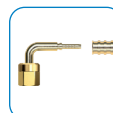

Pg. G-30



- PS1: maximum werkdruk bij werkingstemperatuur 140/-10°C.
- PS2: maximum werkdruk bij werkingstemperatuur -10/-40°C.

### Geluidsdempers niet instelbaar

Art. Nr	Type	ODS	Volume	P1	P2	VH.	Prijs
		inch	dm <sup>3</sup>	Bar	Bar	m <sup>3</sup> /u	
00005350	GD10	3/8	0,3	53	10	7,5	84,77
00005351	GD12	-	0,3	53	10	12	84,77
00005352	GD 1/2"	1/2	0,3	53	10	12	84,77
00005353	GD15	-	0,3	53	10	18	84,77
00005354	GD16	5/8	0,3	53	10	23	84,77
00005355	GD18	-	0,3	53	10	30	87,64
00005356	GD 3/4"	3/4	0,3	53	10	30	87,64
00005357	GDS22	7/8	0,3	53	10	42	87,64
00005358	GD22	7/8	1,1	45	10	42	124,12
00005359	GD28	1 1/8	1,1	45	10	74	131,28
00005360	GDS35	1 3/8	1,1	45	10	110	134,14
00005364	GD35	1 3/8	2,3	45	10	110	161,68
00005365	GD42	1 5/8	2,3	45	10	170	204,96
00005366	GD54	2 1/8	3,6	45	10	290	476,10
00005367	GD67/64	2 1/2	3,6	45	10	350	531,90
00005368	GD67	2 5/8	3,6	45	10	450	510,44
00005369	GD67/70	2 3/4	3,6	45	10	450	603,44
00005370	GD80/76	3	3,6	45	10	550	603,44
00005371	GD80	3 1/8	3,6	45	10	650	596,64



- PS1: maximum werkdruk bij werkingstemperatuur 140/-10°C.
- PS2: maximum werkdruk bij werkingstemperatuur -10/-40°C.

### Geluidsdempers instelbaar

Art. Nr	Type	ODS	Volume	P1	P2	Prijs
		inch	dm <sup>3</sup>	Bar	Bar	
00052815	GDX18/12	1/2	0,8	31	10	323
00051540	GDX16	5/8	0,8	31	10	323
00056759	GDX18	-	0,8	31	10	323
00005373	GDX22	7/8	1,5	31	10	437
00005374	GDX28	1 1/8	1,5	31	10	472
00005375	GDX35	1 3/8	1,5	31	10	472
00014804	GDX42	1 5/8	1,5	31	10	642
00056760	GDX54	2 1/8	2	31	10	1 096
00056761	GDX67/64	2 1/2	2	31	10	1 025
00056762	GDX67	2 5/8	2	31	10	1 078
00056764	GDX67/76	3	2	31	10	1 234
00056765	GDX67/80	3 1/8	2	31	10	1 234



Pg. F-32



## NIVEAUCONTROLESYSTEMEN

AC&R

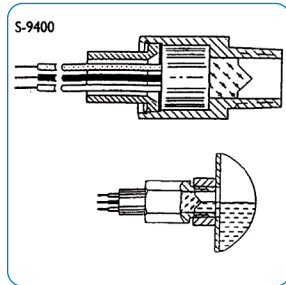

- Verkrijgbaar met NO en NC contact
- Verkrijgbaar 24AC/DC of 240V 50Hz
- Bedrading Zwart en Wit = NC contact
- Bedrading Zwart en Wit gestreept= NO contact
- Rood= schakelende voeding naar te monteren relais

NO: relais sluit als vloeistof te laag komt  
NC: relais opent als vloeistof te laag komt

### Niveaucontrolesysteem

Art. Nr	Type	Spanning	Aansluiting	Contact	Min/Max temp	Prijs
					°C	EUR
00012002	S-9420	230V/50Hz	1/2" NPT	NC	-40/93	345,28
00012001	S-9420A	230V/50Hz	1/2" NPT	NO	-40/93	359,66
00058249	S-9424A	24V AC/DC	1/2" NPT	NO	-40/98	330,89

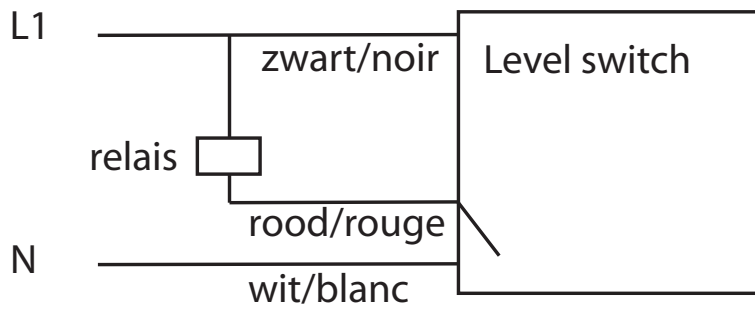

F

F-46

Let op: De prijzen in deze catalogus zijn een momentopname en kunnen wijzigen. De actuele prijzen vindt u steeds op onze webshop.

## WARMTEWISSELAARS GAS-VLOEISTOF



### Warmtewisselaar

Art. Nr.	Type	Nominaal debiet	Conn. gas	Conn. vloeistof	Lengte	Druk	Gewicht	Prijs
		kW	Inch	Inch				
00011594	HX1/2 (SLHE-0,5)	0,37	1/2"	1/4"	29,21	34,48	0,45	209
00006766	HX1 (SLHE-1,0/HX1)	0,75	5/8"	3/8"	34,93	48,28	0,90	222
00006767	HX1 1/2 (SLHE-1,5)	1,12	7/8"	3/8"	36,83	48,28	0,90	273
00006768	HX3 (SLHE-3)	2,24	1 1/8"	1/2"	38,10	48,28	1,35	351
00006769	HX5 (SLHE-5)	3,73	1 3/8"	5/8"	36,20	27,59	1,80	640
00006770	HX7 1/2 (SLHE-7,5)	5,60	1 5/8"	5/8"	43,18	27,59	1,80	667
00006771	HX10 (SLHE-10)	7,46	2 1/8"	7/8"	45,72	27,59	3,15	1 189
00006772	HX20 (SLHE-20)	14,92	2 1/8"	1 1/8"	68,58	27,59	4,95	2 400
00014327	HX30 (SLHE-30)	22,38	2 5/8"	1 3/8"	73,34	31,03	7,65	2 597
00006773	HX50 (SLHE-50)	37,30	3 1/8"	1 5/8"	73,34	31,03	9,00	3 490
00006774	HX75 (SLHE-75)	55,95	4 1/8"	2 1/8"	75,88	31,03	14,40	4 514

## FLEXIBELE LEIDINGEN IN INOX

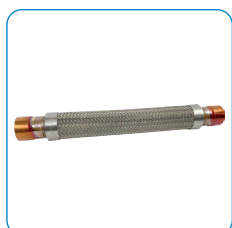

### Trillingsdemper in roestvrij staal, koperen aansluitingen

Art. Nr.	Type	Aansluiting	Lengte	PS	Prijs
		Inch	mm	bar	
00052783	VABD02SS (WT-2)	1/4"	202	45	69
00100455	7690/3	3/8"	230	35	33
00100456	7690/4	1/2"	230	35	38
00100457	7690/5	5/8"	255	35	41
00100458	7690/6	3/4"	255	35	49
00100459	7690/7	7/8"	290	35	61
00100460	7690/9	1.1/8"	330	35	74
00100461	7690/11	1.3/8"	375	35	123
00100462	7690/13	1.5/8"	430	35	172
00100463	7690/17	2.1/8"	510	35	262
00100464	7690/21	2.5/8"	690	25	579
00100465	7690/24	3"	690	25	668
00100466	7690/25	3.1/8"	710	25	668
00100467	7690/28	3.1/2"	710	25	892
00025881	VABD29SS (WT-29)	3.5/8"	812	13	2 415
00005704	VABD33SS (WT-33)	4.1/8"	832	13	2 686
00100468	7690/34	4.1/4"	710	25	1 115

F

F-47

V-26/1/2026



## Uw persoonlijke online toegang tot al onze diensten



V-26/1/2026

Via myFrigro heeft u altijd toegang tot het online gedeelte van Frigo. Een beperkt gedeelte is publiek toegankelijk. Indien u myFrigro ten volle wilt benutten, raden we u aan om een persoonlijke myFrigro login aan te vragen.

### Uw voordelen

1. Steeds bereikbaar.
2. Gebruik onze handige tools voor het maken van berekeningen en offertes.
3. Beheer uw Frigo-administratie.
4. Wordt beloond met e-Points en spaar voor mooie geschenken.





### Online hulpmiddelen

	Webshop met nettoprijzen en voorraadweergave		Online toolbox voor berekeningen en selecties
	Ontwerp gepersonaliseerde offertes voor uw klanten		Raadpleeg technische fiches, handleidingen en foutcodes

F

F-48

### Uw online Frigo administratie

	Beheer uw account		Raadpleeg uw Frigo facturen en creditnota's
	Ruil uw e-Points om voor geschenken		Raadpleeg uw online bestelhistoriek

Vraag vandaag nog uw persoonlijke login aan via: [www.frigro.be](http://www.frigro.be)